



# TECHNICAL MANUAL

Tooling systems and application consulting for the milling of complex 2.5 and 3D geometries



 **pokolm**

PREMIUMTOOLS. WE KNOW HOW.

# TECHNICAL MANUAL

## New technical manual from POKOLM

Dear customer,

This technical manual is intended as a compendium of important technical information that complements the POKOLM product catalogues on holders, milling cutter bodies for indexable inserts and solid carbide end mills or partially summarises their technical content once again in one work.

It completes the innovative catalogue system with the POKOLM Box and is designed precisely for users who are deeply involved with this exciting topic. At the same time, this is also our daily motivation and is what constitutes our profession: the optimisation of milling technology and all the associated processes.

But even such an excellent catalogue is no substitute for sound technical advice. So take advantage of the service and the expertise of our applications engineers, who will work together with you to develop the ideally matched milling strategy for your specific application. That optimally prepares you for stiff competition.

We are happy to be of service and look forward to hearing from you!

Your Pokolm Team



### Imprint

**Pokolm**  
**Frästechnik GmbH & Co. KG**

Adam-Opel-Straße 5  
33428 Harsewinkel  
Germany

fon: +49 5247 9361-0

fax: +49 5247 9361-99

E-Mail: [info@pokolm.com](mailto:info@pokolm.com)

Internet: [www.pokolm.com](http://www.pokolm.com)

[WWW.POKOLM.COM](http://WWW.POKOLM.COM)

© 2014 Pokolm Frästechnik GmbH & Co. KG

All rights reserved. Reproduction, modification, and any type of duplication in whole or in part is prohibited without written consent. This documentation replaces all previous issues. Dimensions and designs contained in previous documentation in digital or printed form may have changed as a result of modified standards. We reserve the explicit right to make changes based on new standards or technical advancements.

The graphical depiction of products is for clarification purposes and does not always correspond in every case with every detail to the actual design.

Items conforming to older standards are delivered until their stocks are exhausted. NO liability is accepted for defects.

## BENEFIT FROM OUR SUCCESS STORY

Being better means continuously thinking about the competition and your own products and services, identifying potential optimisation and above all, developing innovations, which constitute real progress and benefit. In cutting/milling technology, lighter, significantly faster machines led to fundamental changes, which required new cutters for higher feed rates and considerably smaller cutting depths closer to the contour. The founder of our company, F.-J. Pokolm played a decisive role in this important milling cutter body development step with many innovations that are now considered to be the standard. For example, unlike the inch sizes commonly used before, today milling cutter bodies and inserts in metric sizes simplify calculation of the relevant values. The embedded insert seat is a POKOLM innovation, for which we have the inventive genius and practical experience of the founder of our company to thank. The patented DUOPLUG® system with its significantly increased holding forces and maximum concentricity is thought by the industry to be the perfect screw connection between tool and the toolholder. A current cutting/milling technology milestone is the SPPINWORX® round insert cutter with self-rotating inserts.

Top quality and precision standards during development and series production, not only in-house but also at our suppliers, also form an indispensable basis for this success.

This applies just as much to the area of solid carbide end mills used for our own production. And here POKOLM customers benefit from our own high standards of quality; only tools of this highest grade qualify for our extensive range of solid carbide end mills.



Successful practitioners consciously opt for POKOLM premium tools and benefit from this decision. This little bit "more" that gives POKOLM customers the decisive competitive advantage, results automatically from the interaction of

excellent products and outstanding technical advice provided by our technical field service, which is completely and individually orientated to every single customer.

# PURCHASE- AND INFO-HOTLINE



**Pokolm**

**Frästechnik GmbH & Co. KG**



+49 5247 9361-0



+49 5247 9361-99



7:30 a.m. - 6:00 p.m. (on working days)

⌚ **Your purchase up to 5:00 p.m. for same-day shipping!**

**We want to simplify your problems:  
Benefit from our additional services!**

**"Click" for an electronic quotation!**

On request we will send you a quotation or your order confirmation as a PDF file by email.

This means that all information is just one "mouse click" away! With links to detailed technical information.

**Individual advice:** the QR codes are the shortest route to contacts on our website!



Sales  
office

Technical field service  
National



Technical field service  
International

## TABLE OF CONTENTS

General information

from page 2

Know-how

from page 14

Technical information

from page 30

Assembling instructions

from page 50

Forms

from page 62

Quickfinder

from page 67



# VARIETY OF THE HIGHEST QUALITY

The intelligent POKOLM tooling system has the optimum tool for your every need – from the adapter to the milling cutter body or solid carbide cutter through to the insert in various geometries, qualities and coatings. Competent advice from our technical sales representatives, first-class service, a complex range of accessories and further training for our customers in the POKOLM Academy complete our full service concept. In this way we support your success in all areas of the process chain, sustainably.

## Milling cutter bodies for every use

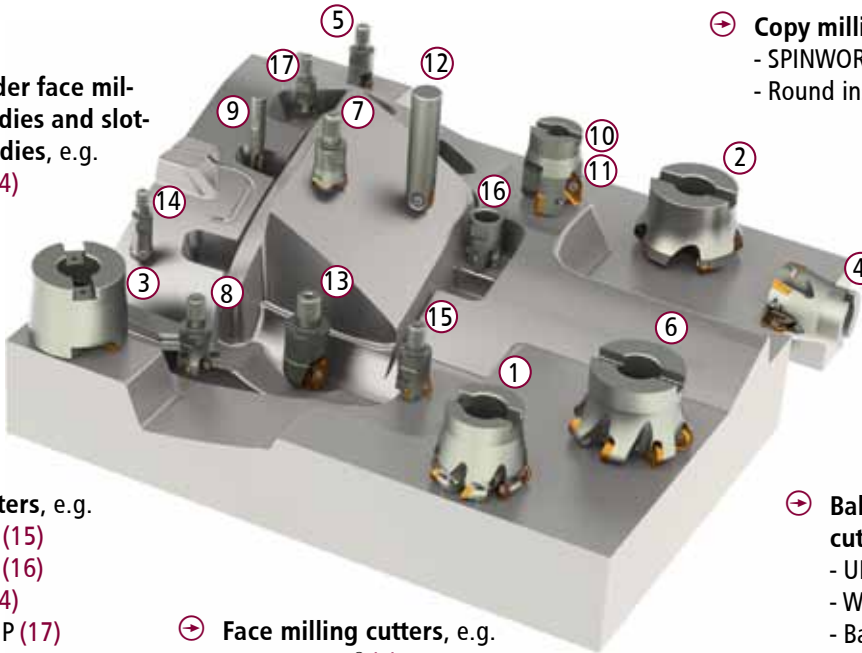

- ➔ Square shoulder face milling cutter bodies and slotting cutter bodies, e.g.
  - SLOTWORX® (4)
  - ADEW (5)
- ➔ High-feed cutters, e.g.
  - QUADWORX® (15)
  - TRIGAWORX® (16)
  - SLOTWORX® (4)
  - SLOTWORX®HP (17)
- ➔ Face milling cutters, e.g.
  - BASEWORX® (1)
  - PLANWORX® (2)
  - MIRROWORX® (3)
- ➔ Rhombic cutters, e.g.
  - FINWORX® (8)
  - XDHW | XDHT (9)
- ➔ Copy milling cutters, e.g.
  - SPINWORX® (6)
  - Round insert cutters (7)
- ➔ Cutters for machining non-ferrous materials, e.g.
  - VDGT (10)
  - VCGT (11)
- ➔ Ballnose / bull end mill cutters, e.g.
  - UNIWORX® (12)
  - WAVEWORX® (13)
  - Ball nose end mills with 4 cutting edges (14)

## The complete POKOLM product range for every aspect of milling technology



Milling cutter bodies



Adapter systems



Accessories



Indexable inserts



Spindle systems  
Shrink technology



Detailed technical  
know-how



Solid carbide cutters



Special products



Qualified service

# THE POKOLM BOX – THE INNOVATIVE CATALOGUE-SYSTEM



# QR-CODES – THE QUICKEST WAY TO OUR WEB PRESENCES



[pokolm.com](http://pokolm.com)

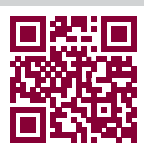

[facebook.com](https://facebook.com)

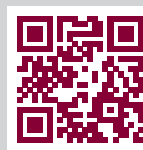

[twitter.com](https://twitter.com)

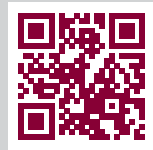

[youtube.com](https://youtube.com)



# THE POKOLM TOOL SYSTEM

over 50000 combination possibilities

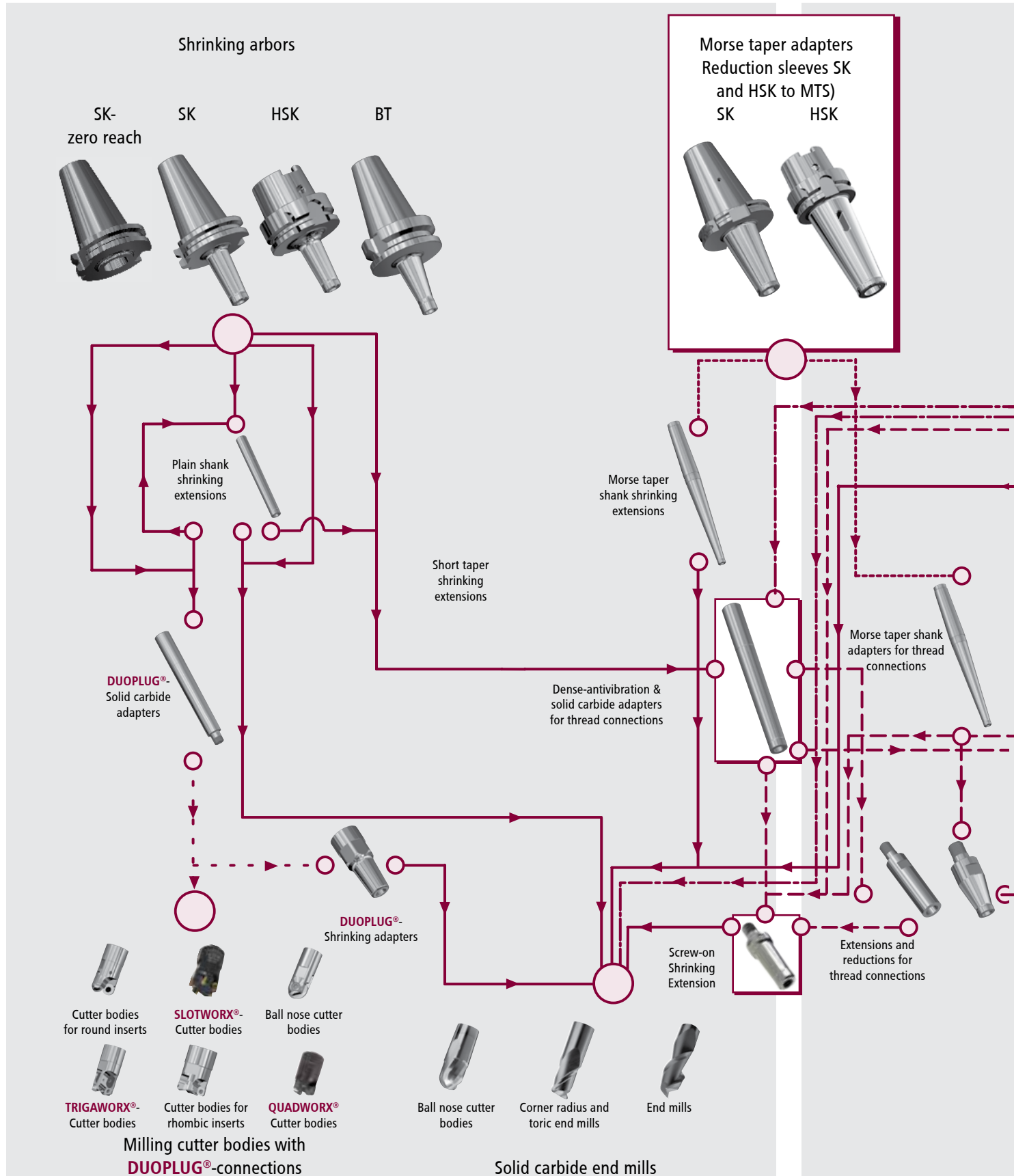



- Shrinking combinations
- - - - - Morse taper combinations
- Thread connected combinations
- - - - - Shell-type combinations
- - - - - ER-Collet combinations
- - - - - DUOPLUG®-combinations

The listed options are applications examples. Do not hesitate to contact our technical field service for a huge number of further possible combinations.

### Arbors for thread connections

SK HSK BT

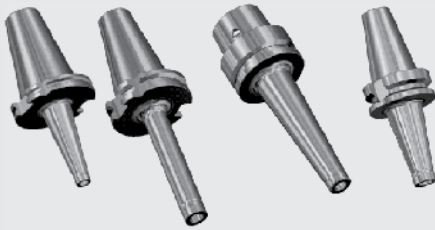

### ER-Collet chucks arbors

SK HSK BT

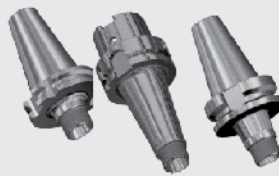

### Arbors for shell-type milling cutter bodies

SK HSK BT Direct spindle mounting

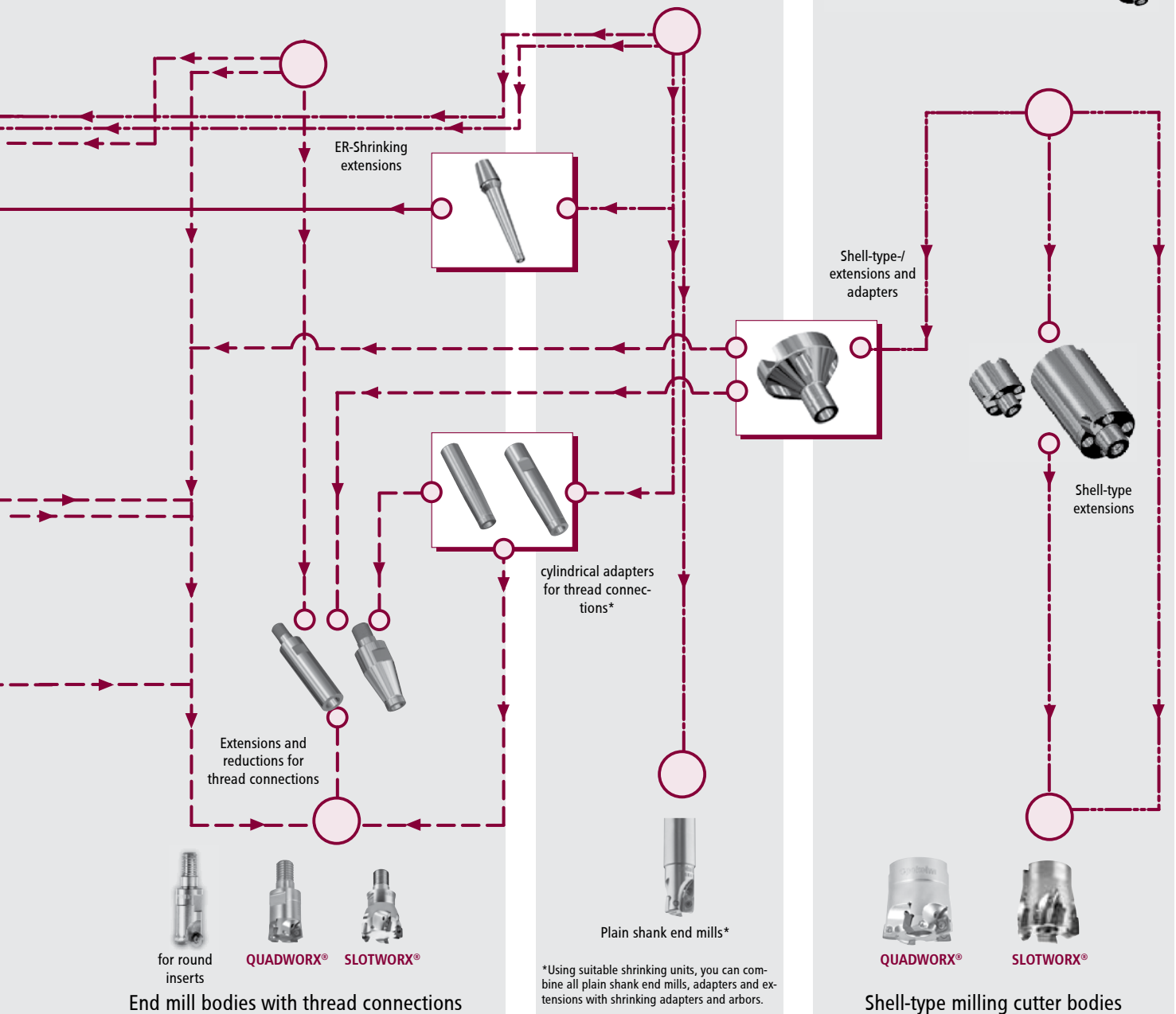
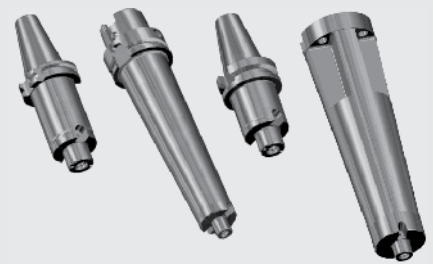

for round inserts  
**QUADWORX®** **SLOTWORX®**  
End mill bodies with thread connections

\*Using suitable shrinking units, you can combine all plain shank end mills, adapters and extensions with shrinking adapters and arbors.

**QUADWORX®** **SLOTWORX®**  
Shell-type milling cutter bodies

# MILLING CUTTER BODIES



## Well incorporated: For multiple advantages in milling.

For Pokolm-milling cutter systems, all bodies are completed by a fine tuned insert-range, leading to an extensive choice of tooling, covering about 90% of every possible application in mould- and die-Making.



Our patent protected, specially incorporated insert seats offer optimum support and insert-life during all milling operations by outstanding rigidity, in particular, when using high feed rates.



Tools with 0° axial rake angle (neutral) and with a variety of positive rake angles offer optimum cutting conditions for a wide range of all possible materials to be machined.



The latest Pokolm **DUOPLUG**®-adapter- and milling cutter system eliminates the looseness between adapter and cutter body. Together with the enormous retention forces and adhesive strength through the shrinking process, you reach a high quality surface finish, even for extreme milling operations and long reach overhang.



Reliability in case of roughing operations. The shims have 2 functions: shock absorber and protection at the same time. Increased process reliability with positive influences to smooth running are further characteristics of this product feature.



For machining non-ferrous materials of all kinds, we offer specially designed tools with special insert geometries and optimum coatings with lubricating additives.



In keeping latest state-of-the-art developments: Nearly all the tools in the Pokolm range are equipped with an internal coolant supply.



Milling cutters with our special 2-point contact milling design can be used for 90° plunge angles.



Optimized tool-geometries, carbide grades and coatings, specially developed for the characteristics of stainless-, acid- and heat-resistant materials, guarantee excellent machining results.

Further information about special features of our POKOLM-tooling systems are indicated on following pages.

# INDEXABLE INSERTS

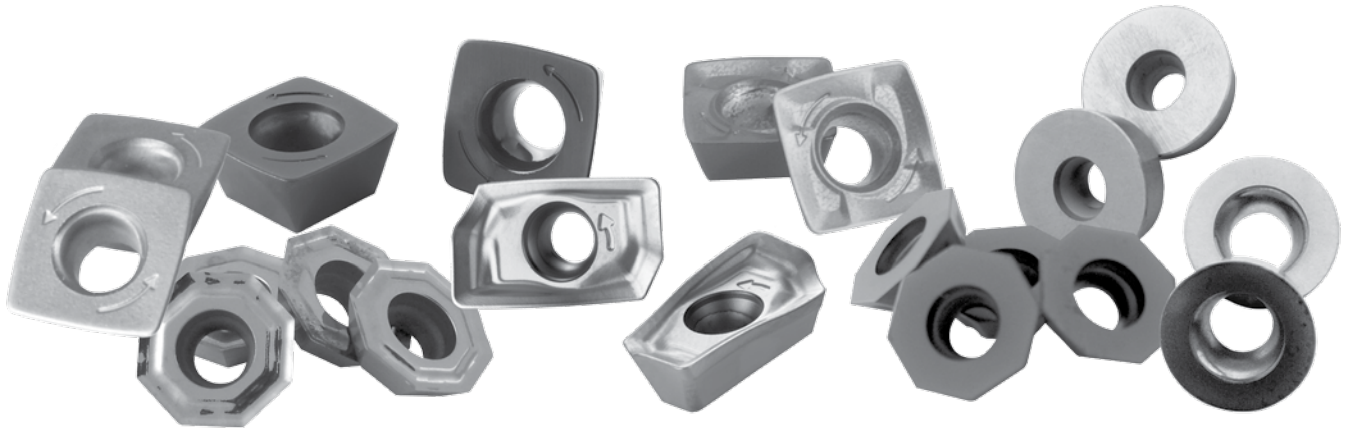

## The complete range.

Our carefully planned, wide variety of indexable inserts is one of the highlights of the Pokolm program.

A perfect complement to our milling cutter program, it offers a wide selection of carbide grades, geometries, and different application possibilities. The range provides an optimum solution for every task:

Diameters from 5 to 20 mm (radii of 2.5 to 10 mm), different shapes, carbide grades, and coatings – along with a great variety of milling cutter bodies, our patent-protected insert seats, and arbor systems – allow every individual combination.

All Pokolm inserts have been developed based on shop-tested applications by our customers, and we improve our inserts to meet every new challenge.

This constant and innovative developmental process, and a remarkably intensive cooperation with our carbide suppliers and coating partners, guarantee state-of-the-art types of inserts at all times.

## SOLID CARBIDE END MILLS



### A complete line of products, full of systematic advantages.

Here is the best argument straight away for POKOLM solid carbide end mills: we use our own end mills to produce a large proportion of our milling cutter bodies and arbors - and for good reason. Our own solid carbide end mills are famous for its precise concentricity, plus it is suitable for shrinking processes and have a full range of advantages in high-speed and extreme milling operations.

We use specially selected materials and have suppliers and coating partners, who are integrated in our developmental and production process. This creates the most favourable environment for our highly specialized staff to produce first class, high-quality end mills using the latest high-tech grinding machines. A wide variety of differentiated cutter geometries and corresponding coatings and a broad range of diameters and working lengths make up a comprehensive product range in order to handle almost any task you can think of.

The entire range of our solid carbide end mills is a part of our tool system and each one is precisely coordinated with all the other tools in our catalogue.

Right from the developmental stage, our tools are conceived and planned in detail together with our suppliers. We also maintain a close partnership and intensive collaboration with our raw materials suppliers and coating partners.

We understand the development of individual products as a process and thus, we guarantee high-quality final products. Furthermore, our solid carbide tools are created almost exclusively as a result of our close customer relations and are almost always developed out of individual solutions, that we devise into catalogue tools.

# YOUR KNOW-HOW CENTRE: THE POKOLM ACADEMY

**F**irst-class products are one thing. But the basis for tooling systems that are more economical, faster and more efficient is: KNOWLEDGE. Which is why we started the POKOLM Academy for you.

Here the aim is to actively find new solutions, to pass on knowledge and to secure long-term competitive advantages.

Continuous training and vocational development is of decisive importance to master market challenges. In the POKOLM Academy we offer you professional workshops, seminars and training course which pass on in-depth product knowledge. An important key to your success.



## Added value through knowledge

To secure and expand the market position From metallurgy along with tools and their coatings to strategies for CNC mills and their programming – proven experts and specialists present their expertise in the academy. And that puts your employees at the cutting edge of everything.



# IMPORTANT PARAMETERS FOR MATERIAL REMOVAL: MEAN CHIP THICKNESS RATIO

## Special features of milling cutter bodies with round inserts

The specific, comma-like shape of chips results in a chip cross section that starts with a thickness of  $f_z$  and goes down to zero (0). Therefore, it is best to use the mean chip thickness ratio  $h_m$  to calculate the operation data.

### Calculation of theoretical mean chip thickness ratio

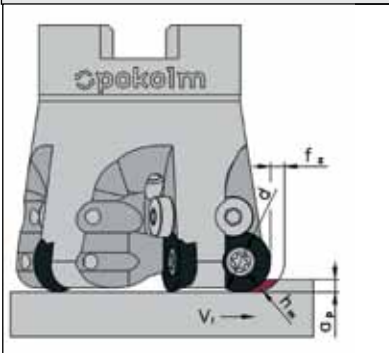

**Formula:** 
$$h_m \approx f_z \sqrt{\frac{a_p}{d}} * \sqrt{\frac{a_e}{D_c}}$$

**Formula:** 
$$f_z \approx h_m \sqrt{\frac{d}{a_p}} * \sqrt{\frac{D_c}{a_e}}$$

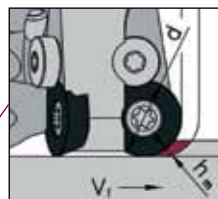

Comparison to rectangular inserts

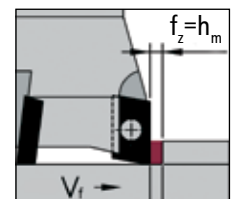

### Machining example:

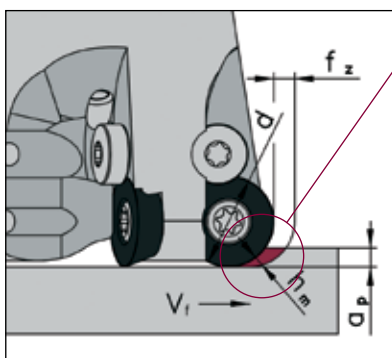

- Milling cutter: 35 200
- No. of effective teeth: 3
- Requested  $h_m$ : 0,15
- Size of insert: Ø 12 x 3,97 mm
- Depth of cut  $a_p$ : 2
- Width of cut  $a_e$ : 60%

$$f_z \approx 0,15 \sqrt{\frac{12}{2}} * \sqrt{\frac{35}{60\% * 35}} = 0,47 \text{ mm}$$

**This means:**

Using round inserts results in an increase of the feed rate by a factor of 2.4!

#### Recommended mean chip thickness for round inserts:

WSP Ø	5	7	10	12	16	20
hm	0,07	0,1	0,15	0,15	0,2	0,25

### Definitions and dimensions:

- $a_p$  depth of cut [mm]
- $d$  diameter of insert [mm]
- $f_z$  feed per tooth in [mm]
- $h_m$  mean chip thickness ratio [mm]

# TECHNOLOGY OVERVIEW

## MILLING CUTTER BODIES

### ➔ Increased economic efficiency

Our seven different diameters for round inserts alone, plus numerous additional geometries and sizes – combined with five different rake angles in our milling cutter bodies – provide optimum cutting conditions for almost every application you can think of.

Large variety of rake angles for every special application.



negativ rake angle for maximum stability and smooth running



0° rake angle, the best solution for high accurate contour milling and machining hardened materials



milling cutter bodies with positive rake angles are suitable for nearly every application, together with inserts with concave molding they are the best solution for machining RSH materials

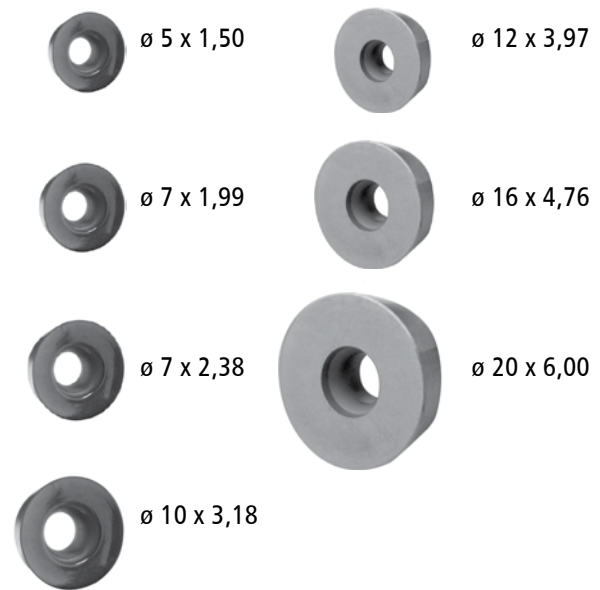

### Optimum load distribution

The patent-protected, specially developed insert seats in our milling cutter bodies absorb all axial and radial milling forces, because the insert is not only fixed with a Torx® screw, it is also supported by being embedded into the cutter body. Thus, the cutting pressure no longer acts on the screw alone, but is also absorbed by our milling cutter bodies.

Compared to open insert seats, our incorporated insert seats allow stronger teeth, clearly improving the rigidity of our milling cutters. This results in longer tool life and allows higher feed rates. Additional double clamps provide excellent support, even under extreme cutting conditions.

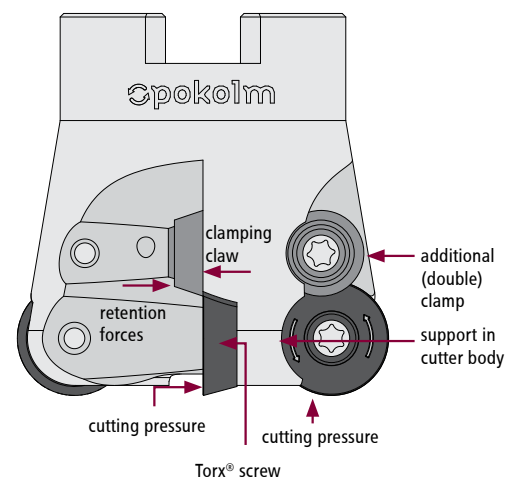

### Reduced wear

Our chip spaces were specially designed for exceptionally easy chip flow, thus protecting both body and workpiece from damage. The supply channels for the coolant in arbors and cutter bodies are precisely coordinated with each other so that the coolant is conducted directly onto the cutting edge even under difficult cutting conditions.

Specially selected materials and extra-hard coatings offer higher tensile strength and heat resistance, making Pokolm tools and arbor systems unbeatable in durability and long-life-cycles.

# SURFACE FINISH

The goal when finishing a component is, to avoid or at least minimize the necessity for manual retouching. However, many factors influence the surface finish of a milled component:

- ⊕ workpiece geometry, material
- ⊕ rigidity of the clamp and the machine
- ⊕ length of overhang and cutting data
- ⊕ precision, geometry and design of cutting tools and arbors

In addition to these points, the desired surface-roughness  $R_{th}$  definitively influences both the surface finish and the machining times needed for finishing. The well-informed selection of operation data to achieve a defined surface roughness saves valuable time in every finishing operation and ensures competitive machining times.

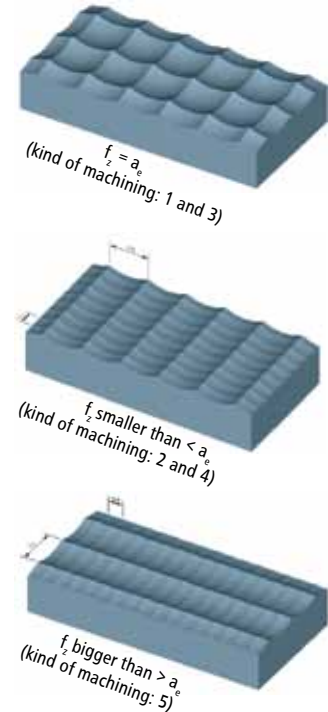

## MACHINING EXAMPLE:

<b>Material:</b> 1.2312, SK40-machine	<b>Surface to be machined:</b> 150 x 200 mm
<b>Milling cutter:</b> 08 214 with $d_1 = 8, z = 2$	$n = 14000$ rpm $V_c = 350$ m/min

	from		resulting in:	surface roughness in [mm]	milling length in [mm]	machining time
	$f_z$	$a_e$	$V_f$			
kind of machining 1	0,08	0,08	2.240	0,0002	375.000	2 h 47 min
kind of machining 2	0,08	0,16	2.240	0,0008	187.500	1 h 24 min
kind of machining 3	0,16	0,16	4.480	0,0008	187.500	42 min
kind of machining 4	0,16	0,32	4.480	0,0032	93.750	21 min
kind of machining 5	0,32	0,16	8.960	0,0008	187.500	21 min

### You can roughly say that:

- ⊕ Doubling either your width of cut or your feed rate reduces your machining time by 50 %.

Selecting identical values for  $f_z = a_e$  produces in most cases a very smooth surface, which stands out for its symmetrical surface-finish in feed motion and feed direction.

$f_z = a_e$  results in:

- ⊕ doubling both of these values reduces machining time to one quarter.
- ⊕ reducing  $f_z$  and  $a_e$  by half, however, increases surface smoothness fourfold.

### Definitions and dimensions:

$d_1$  tool diameter in [mm]

$d_{eff}$  true tool diameter in action in [mm]

$r$  tool radius in [mm]

$R_{th,ae}$  surface roughness in feed direction in [mm]

$R_{th,fz}$  surface roughness in feed motion in [mm]

$a_e$  width of cut in [mm]

$f_z$  feed per tooth in [mm]

$\beta$  approach angle of tool axis in [°]

$a_p$  depth of cut in [mm]

## COLLECTION OF FORMULAS

### 1a Calculation of theoretical surface roughness in advance direction

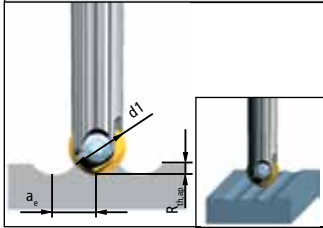

**Formula:**

$$R_{th,ap} = \frac{d_1}{2} - \sqrt{\frac{d_1^2 - a_p^2}{4}}$$

**Example:**

$$\begin{aligned} d_1 &= 12 \\ a_p &= 0,2 \end{aligned}$$

$$R_{th,0,2} = \frac{12}{2} - \sqrt{\frac{12^2 - 0,2^2}{4}} = 0,000833$$

### 1b Calculation of theoretical surface roughness in feed direction

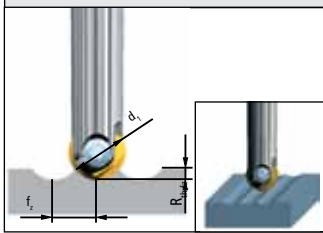

**Formula:**

$$R_{th,fz} = \frac{d_1}{2} - \sqrt{\frac{d_1^2 - f_z^2}{4}}$$

**Example:**

$$\begin{aligned} d_1 &= 12 \\ f_z &= 0,2 \end{aligned}$$

$$R_{th,0,2} = \frac{12}{2} - \sqrt{\frac{12^2 - 0,2^2}{4}} = 0,000833$$

### 2a Calculation of true cutting diameter of ball nose end mills in the case of vertical axis

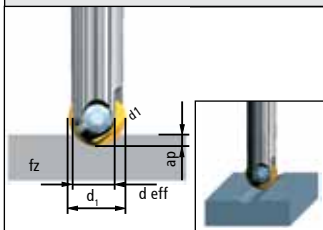

**Formula:**

$$d_{eff} = 2 \sqrt{a_p (d_1 - a_p)}$$

**Example:**

$$\begin{aligned} d_1 &= 12 \\ a_p &= 0,2 \end{aligned}$$

$$d_{eff} = 2 \sqrt{0,2 \cdot (12 - 0,2)} = 3,07$$

Don't waste your time on calculations:

Here is our chart for the true diameters of ball nose end mills depending on depth of cut:

End mill diameter $d_1$ :												
$a_p$	1	2	3	4	5	6	7	8	10	12	16	20
0,1	0,60	0,87	1,08	1,25	1,40	1,54	1,66	1,78	1,99	2,18	2,52	2,82
0,2	0,80	1,20	1,50	1,74	1,96	2,15	2,33	2,50	2,80	3,07	3,56	3,98
0,3	0,92	1,43	1,80	2,11	2,37	2,62	3,84	3,04	3,41	3,75	4,34	4,86
0,4	0,98	1,60	2,04	2,40	2,71	2,99	3,25	3,49	3,92	4,31	5,00	5,60
0,5	1,00	1,73	2,24	2,65	3,00	3,32	3,61	3,87	4,36	4,80	5,57	6,24

**2b Calculation of true cutting diameter of ball nose end mills using an action angle of spindle**

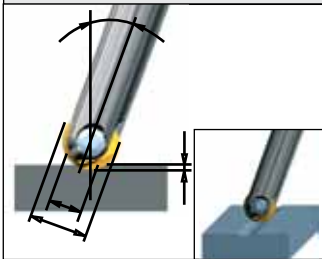

**Formula:**

$$d_{\text{eff}} = d_1 \cdot \sin \left( \beta + \arccos \left( 1 - \frac{2 \cdot a_p}{d_1} \right) \right)$$

Formula applies to positive approach angles

$$d_{\text{eff}} = 12 \cdot \sin \left( 15 + \arccos \left( 1 - \frac{2 \cdot 0,2}{12} \right) \right) = 5,97$$

**Example:**  
 $d_1 = 12$   
 $a_p = 0,2$   
 $\beta = 15^\circ$

True cutting diameters change when you use ball nose end mills in spindles, using an approach angle. Depth of cut ( $a_p$ ) stays constant, but the area of the end mill diameter that is actually cutting is reduced. This requires another method of calculating the true cutting diameter.

Don't waste your time on calculations.

Here is our chart for true cutting diameters of ball nose end mills depending on the approach angle and the depth of cut:

		End Mill Diameter $d_1$ :											
$\beta$	$a_p$	1	2	3	4	5	6	7	8	10	12	16	20
10°	0,1	0,73	1,17	1,55	1,89	2,21	2,52	2,82	3,11	3,66	4,20	5,23	6,22
	0,2	0,89	1,46	1,93	2,34	2,73	3,09	6,44	3,78	4,42	5,04	6,21	7,32
	0,3	0,97	1,65	2,19	2,67	3,10	3,51	3,90	4,28	4,99	5,67	6,95	8,16
	0,4	1,0	1,78	2,39	2,92	3,40	3,85	4,28	4,68	5,46	6,19	7,56	8,85
	0,5	0,98	1,88	2,55	3,13	3,65	4,13	4,59	5,03	5,86	6,63	8,09	9,45
15°	0,1	0,79	1,31	1,77	2,19	2,59	2,99	3036	3,74	4,46	5,16	6,53	7,85
	0,2	0,93	1,57	2,12	2,62	3,08	3,53	3,69	4,38	5,19	5,97	7,47	8,92
	0,3	0,99	1,74	2,36	2,92	3,43	3,92	4,40	4,85	5,73	6,57	8,18	9,72
	0,4	1,00	1,86	2,54	3,15	3,71	4,24	4,74	5,23	6,17	7,06	8,76	10,38
	0,5	0,97	1,92	2,68	3,33	3,93	4,50	5,04	5,55	6,54	7,48	9,26	10,95
20°	0,1	0,84	1,43	1,97	2,47	2,96	3,43	3,89	4,34	5,22	6,09	7,77	9,42
	0,2	0,69	1,67	2,30	2,87	3,41	3,94	4,45	4,95	5,91	6,85	8,68	10,44
	0,3	1,00	1,82	2,51	3,14	3,74	4,30	8,85	5,39	6,42	7,42	9,35	11,20
	0,4	0,99	1,91	2,67	3,35	3,99	4,59	5,17	5,74	6,83	7,88	9,89	11,83
	0,5	0,94	1,97	2,79	3,51	4,19	4,83	5,44	6,03	7,17	8,27	10,36	12,37
25°	0,1	0,88	1,55	2,16	2,74	3,30	3,84	4,38	4,91	5,95	6,96	8,96	10,92
	0,2	0,98	1,76	2,46	3,10	3,72	4,32	4,90	5,48	6,59	7,69	9,82	11,89
	0,3	1,00	1,89	2,65	3,30	4,01	4,65	5,27	5,88	7,06	8,21	10,44	12,61
	0,4	0,97	1,69	2,78	3,53	4,23	4,91	5,57	6,20	7,44	8,64	10,95	13,19
	0,5	0,91	1,99	2,87	3,67	4,41	5,12	5,80	6,47	7,75	9,00	11,39	13,69
30°	0,1	0,92	1,65	2,33	2,98	3,61	4,23	4,84	5,44	6,62	7,79	10,08	12,34
	0,2	0,99	1,84	2,60	3,31	4,00	4,67	5,32	5,96	7,22	8,46	10,88	13,25
	0,3	0,99	1,94	2,76	3,52	4,26	4,96	5,66	6,33	7,65	8,94	11,46	13,91
	0,4	0,95	1,99	2,87	3,68	4,45	5,19	5,91	6,62	7,99	9,33	11,93	14,45
	0,5	0,87	2,00	2,94	3,79	4,60	5,37	6,12	6,85	8,27	9,65	12,32	14,91

Definitions and dimensions:

- $d_1$  tool diameter in [mm]
- $d_{\text{eff}}$  true tool diameter in action in [mm]
- $r$  tool radius in [mm]
- $R_{\text{th}, a_e}$  surface roughness in feed direction in [mm]
- $R_{\text{th}, f_z}$  surface roughness in feed direction in [mm]
- $a_e$  width of cut in [mm]
- $f_z$  feed per tooth in [mm]
- $\beta$  approach angle of tool axis in [°]
- $a_p$  depth of cut in [mm]



**2c** Calculation of true cutting diameter of toric end mills

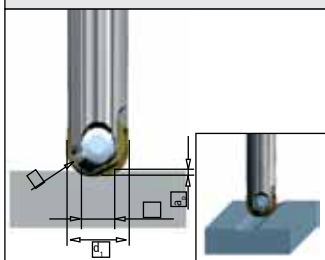

**Formula:**

$$d_{\text{eff}} = (d_1 - 2r) + 2\sqrt{a_p(2r - a_p)}$$

Formula applies to positive approach angles

$$d_{\text{eff}} = (12 - 2 \cdot 5) + 2\sqrt{0,2 \cdot (2 \cdot 5 - 0,2)} = 4,8$$

Example:

$$d_1 = 12$$

$$r = 5$$

$$a_p = 0,2^\circ$$

Don't waste your time on calculations.

Here is our chart for true cutting diameters of toric end mills, depending on corner radius and depth of cut:

		End mill diameter							
r	a <sub>p</sub>	6	8	10	12	15	16	20	25
2	0,1	3,25	5,25	7,25	9,25	-	13,25	17,25	-
	0,2	3,74	5,74	7,74	9,74	-	13,74	17,74	-
	0,3	4,11	6,11	8,11	10,11	-	14,11	18,11	-
	0,4	4,40	6,40	8,40	10,40	-	14,40	18,40	-
	0,5	4,65	6,65	8,65	10,65	-	14,65	18,65	-
2,5	0,1	2,40	4,40	6,40	8,40	11,40	12,40	16,40	-
	0,2	2,96	4,96	6,96	8,96	11,96	12,96	16,96	-
	0,3	3,37	5,37	7,37	9,37	12,37	13,37	17,37	-
	0,4	3,71	5,71	7,71	9,71	12,71	13,71	17,71	-
	0,5	4,00	6,00	8,00	10,00	13,00	14,00	18,00	-
3	0,1	-	3,54	-	-	-	-	-	-
	0,2	-	4,15	-	-	-	-	-	-
	0,3	-	4,62	-	-	-	-	-	-
	0,4	-	4,99	-	-	-	-	-	-
	0,5	-	5,32	-	-	-	-	-	-
3,5	0,1	-	-	-	6,66	9,66	10,66	14,66	19,66
	0,2	-	-	-	7,33	10,33	11,33	15,33	20,33
	0,3	-	-	-	7,84	10,84	11,84	15,84	20,84
	0,4	-	-	-	8,25	11,25	12,25	16,25	21,25
	0,5	-	-	-	8,61	11,61	12,61	16,51	21,61
4	0,1	-	-	3,78	-	-	-	-	18,78
	0,2	-	-	4,50	-	-	-	-	19,50
	0,3	-	-	5,04	-	-	-	-	20,04
	0,4	-	-	5,49	-	-	-	-	20,49
	0,5	-	-	5,87	-	-	-	-	20,87
5	0,1	-	-	-	3,99	-	-	11,99	16,99
	0,2	-	-	-	4,80	-	-	12,80	17,80
	0,3	-	-	-	5,41	-	-	13,41	18,41
	0,4	-	-	-	5,92	-	-	13,92	18,92
	0,5	-	-	-	6,36	-	-	14,36	19,36
7	0,1	-	-	-	-	-	4,36	-	-
	0,2	-	-	-	-	-	5,32	-	-
	0,3	-	-	-	-	-	6,05	-	-
	0,4	-	-	-	-	-	6,66	-	-
	0,5	-	-	-	-	-	7,20	-	-

# KINDS OF TOOL WEAR IN MILLING OPERATIONS

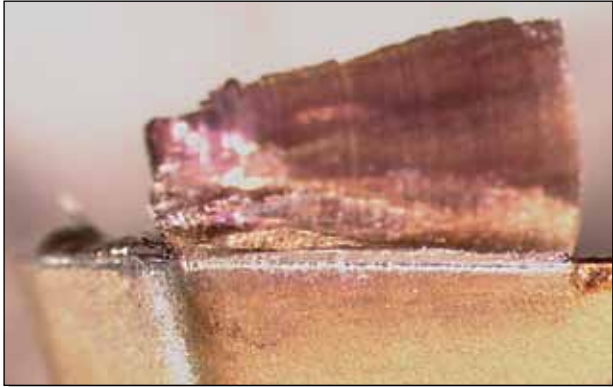

## Built-up edges

Built-up edges cause poor surface finish and cutting-edge chipping when trying to remove material built-up.

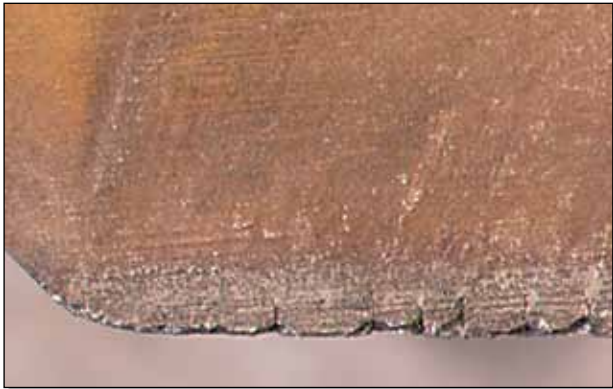

## Chipping

Small cutting-edge chipping leads to poor surface texture and excessive flank wear.

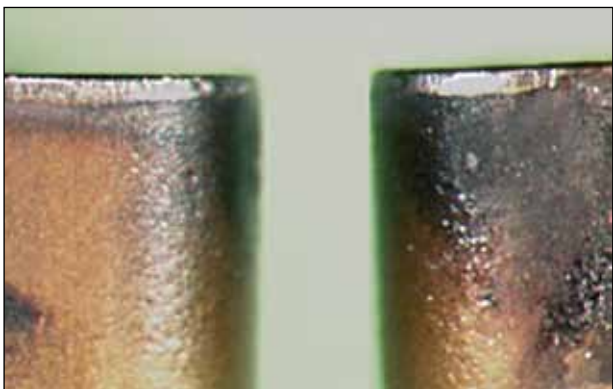

## Flank wear

Rapid flank wear causes poor surface texture or inconsistency of tolerances.



## Thermal cracks

Small cracks perpendicular to the cutting edge cause chipping on workpiece and poor surface finish.

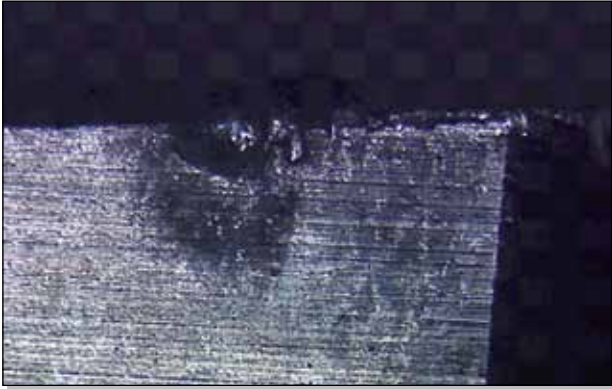

#### **Notch wear**

Notch wear causes poor surface texture and risk of edge breakage.



#### **Crater wear**

Excessive crater wear causes a weakened edge and poor surface finish.

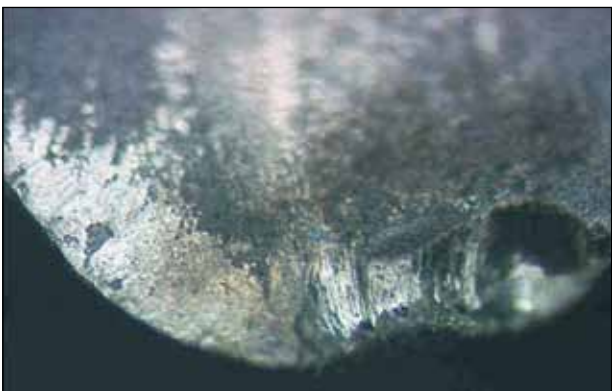

#### **Insert/Edge fracture**

Damages not only the insert but can also ruin the shim and workpiece.



#### **Plastic deformation**

Plastic deformation of edge, depression or flank impression, leading to poor chip control, poor surface and insert breakage.

# OPTIMIZING OF MILLING CONDITIONS AND TOOL LIFE

If you are not satisfied with your machining results, please check the following details:

- ➔ have you selected the appropriate tool and insert diameter for your machine?  
(In both cases it is better to select somewhat smaller diameters.)
- ➔ have you selected the correct insert grade for the material to be machined?
- ➔ do your selected operation data correspond to the recommended data in our catalogue?

Every milling operation is influenced by a very large number of very diverse factors. The following optimizing proposals are only an overview and do not claim to be complete.

For optimum operation data, specially selected for your specific machining application, please ask one of our applications engineers.

## WEAR AND TOOL LIFE

(see also our page "kind of tool wear")

A certain amount of wear during a milling operation is normal. However, if wear occurs after a very short machining time, please consider the following steps:

kind of tool wear	possible causes and solutions
<b>Built-up edge</b>	<ul style="list-style-type: none"> <li>➔ If your cutting speed is too low or your selected feed per tooth too small: this can lead to built-up chips on your cutting edges.</li> <li>➔ If your rake angle or your cutting edge are not optimal, there is a possibility for using our inserts with concave moulding or you might use milling cutter bodies with positive rake angle.</li> <li>➔ If your coolant supply is not optimal, chips starting to weld on your cutting edge. Your coolant flood should be strong enough to reach the point of cutting and can care for sufficient heat removal also.</li> <li>➔ Partly, the use of a different coating leads to improvements.</li> </ul>
<b>Edge chipping</b>	<ul style="list-style-type: none"> <li>➔ If your cutting speed is too low or your selected feed per tooth too small: this can lead to edge chipping. Increasing or reducing those values can achieve improvements.</li> <li>➔ Also a tougher carbide grade reacts against edge chipping.</li> <li>➔ A softer cut of an insert with concave moulding or a cutter with positive rake angle might also solve these problems.</li> <li>➔ A too large depth of cut is an unnecessary stress. Often, reducing of your ap-value and increasing of speed Vc ends up in better results.</li> </ul>

kind of tool wear	possible causes and solutions
<b>Thermal cracks</b>	<ul style="list-style-type: none"> <li>⊕ Increased speeds and increased feeds per tooth excessively stress the cutting edge. If there is no improvement after reduction of the feed rate, following actions are possible:</li> <li>⊕ by selecting a smaller setting angle, the position of the insert towards the component gets improved.</li> <li>⊕ Thermal cracks can also result from heavy temperature changes at the cutting edge. Dry machining as well as sufficient coolant flood can put things right.</li> </ul>
<b>Notch wear</b>	<ul style="list-style-type: none"> <li>⊕ When notch wear occurs, milling chips "grind" material out of the insert at the deepest point of the cutting depth. Reducing of speed and feed rates provide a better chip removal as well as a tougher carbide grade.</li> <li>⊕ Selecting a smaller setting angle and varying of the cutting depth work against those problems.</li> <li>⊕ In case, notch wear is created by burr formation, the alteration of the operation angle of the milling cutter can improve the situation.</li> </ul>
<b>Crater wear</b>	<ul style="list-style-type: none"> <li>⊕ Crater wear is a thermal problem. In case, coolant is not or not in sufficient quantity available at the cutting edge, it gets overheated immediately. The same effect occurs, when speed and feed are increased.</li> <li>⊕ Selection of a more wear resistant carbide grade can also work against this problem of crater wear.</li> </ul>
<b>Edge fracture/ insert breakage</b>	<ul style="list-style-type: none"> <li>⊕ Reason for insert breakage or edge fracture is a mechanical overstressing of the insert. Reasons for that can vary:</li> <li>⊕ incorrect mounting of the insert to the cutter body can result in an air gap. The contact surface of the insert gets too small or gets lost completely.</li> <li>⊕ In case, an excessive wear is recognized, an early insert change might help.</li> <li>⊕ In case, the cutting edge is overstressed, a reduction of cutting depth or selection of a more rigid cutter geometry might help, as well as selection of a tougher carbide grade.</li> <li>⊕ Please try to achieve a better proportion from cutting depth to cutting width by reduction of cutting depth and your sidesteps.</li> <li>⊕ Also, excessive oscillations or vibrations can lead to insert breakage. Please read further instructions under "vibrations".</li> <li>⊕ In case, insert breakage appears always at the same spot in your component, you should check your programming. Perhaps there is a spot with suddenly changing cutting forces, or, in case of finishing operations, too much residual material has been left.</li> </ul>
<b>Plastic deformation</b>	<ul style="list-style-type: none"> <li>⊕ In case, increased cutting temperature and increased cutting forces occur at the same time, it might come to thermal and mechanical deformations of the cutting edge. In order to put things right, you better select a more wear-resistant carbide grade or you look for a considerably increased improvement of your coolant supply.</li> </ul>
<b>Flank wear</b>	<ul style="list-style-type: none"> <li>⊕ Excessive flank wear results from increased speed and a too low feed rate. Adjust these values or select a more wear resistant carbide grade.</li> </ul>

Kinds of wear are in alphabetical sequence



## CIRCUMSTANCES WITH A NEGATIVE INFLUENCE ON A MILLING OPERATION

### Factors, which affect milling results negatively:

kind of tool wear	possible causes and solutions
burr formation	<ul style="list-style-type: none"> <li>➔ Dull cutting edges lead to burr formation. Positive insert geometries (e.g. concave moulding) are able to correct this effect.</li> <li>➔ Unfavourable cutting force direction can be eliminated by selecting another entering angle.</li> </ul>
sticking chips	<ul style="list-style-type: none"> <li>➔ In case of very soft and clogging materials, the use of inserts with coatings containing lubricating additives leads to better chip removal. If inserts, suitable for wet machining are used, the results with coolant floods are possibly better. Higher feed per tooth can also avoid sticking chips. Chips are getting thicker, can absorb more heat and reduce temperature rising of inserts.</li> </ul>
overstressed machines	<ul style="list-style-type: none"> <li>➔ If overstressing of the machine appears, cutting pressure is too high. Common reason is selection of oversized milling cutters and/or oversized inserts. Reduce those parameters and select a more positive tool geometry (7°, 12° or 17°). In order to reduce cutting pressure, speed, feed per tooth and cutting depths can be decreased.</li> </ul>
unwanted scratches/ repeated-cutting	<ul style="list-style-type: none"> <li>➔ Repeated cutting becomes apparent through unwanted scratches and surface scoring. Select smaller tooling or a smaller setting angle. Those actions reduce overstressing. Sometimes, the change of dull inserts already leads to relief and you better check your adjustment angle of your spindle.</li> </ul>
poor surface finish	<ul style="list-style-type: none"> <li>➔ If vibrations (see next page) are not the reason for poor surface finish, it should be checked, if an axial run-out occurs, which can be eliminated by adjustment of spindle, tool holder or tool.</li> <li>➔ For plane faces, the use of inserts with chamfer instead of corner radius, or even special face milling cutters and appropriate inserts are recommended.</li> <li>➔ Or simply, feed per revolution is too high?</li> </ul> <p>Further information about surface finish, you are going to find on page 16.</p>
no chip flow	<ul style="list-style-type: none"> <li>➔ Optimum chip removal is essential in milling operations. Please care for sufficient pressure-air supply and care for avoiding recutting of already removed material.</li> <li>➔ Too small chip room can lead to swarf jamming. Use tools with fewer teeth and more chip room.</li> <li>➔ By reducing depth of cut, width of cut and feed per tooth, chips are getting smaller and chip flow is increased.</li> <li>➔ In case of soft and clogging materials, inserts and solid carbide end mills coated with lubricating additives and positive cutting geometries (e.g. concave moulding) put things right.</li> </ul>

Kinds of wear are in alphabetical sequence.

kind of tool wear	possible causes and solutions
<p><b>Vibrations/chatter</b></p> <div data-bbox="146 568 466 766" style="background-color: #800040; color: white; padding: 5px; transform: rotate(-10deg);"> <p><b>Did you know:</b> Vibrations cause more wear on cutting edges than the actual cutting process.</p> </div>	<ul style="list-style-type: none"> <li>➔ A possible reason is an unsuitable rigidity of the machine. If there is no possibility to change to a more rigid machine, you have to select smaller tooling. We have small inserts for unstable machines in our range. Reducing speed and/or depth of cut are other possibilities for improvements.</li> <li>➔ Further possibilities: avoid poor set-up, avoid long overhangs by reducing the length of your tool-combination.</li> <li>➔ Distinct improvement in rigidity results through use of vibration-reduced combinations like <b>DUOPLUG®</b>, dense- antivibration adapters or monobloc arbors, because the number of interfaces is smaller. For SK50 machines, we recommend direct spindle mounting, using the flange contact surface of the machine.</li> <li>➔ For machining deep cavities with long overhang, we offer – in addition to the above-mentioned possibilities – special <b>TRIGAWORX®</b>-or <b>QUADWORX®</b>-tooling with long reach and coarse tooth pitches</li> <li>➔ In case of unstable set-ups, you should change to a more rigid set-up where the elements are clamped directly on to the machine table.</li> <li>➔ Finally, vibrations can also originate from resonances. In this case, the problem can be solved by altering the speed, increasing feed per tooth or selecting a more positive cutter geometry.</li> </ul>
<p><b>Fracture of component</b></p>	<ul style="list-style-type: none"> <li>➔ Component fractures due to increased cutting forces could be avoided by sharper cutting edges and more positive cutter geometries.</li> <li>➔ Probably, an unfavourable direction of cutting forces has to be altered. In that case, the change from climb milling to conventional milling could improve the situation.</li> <li>➔ Particularly, in brittle material, fracture can be avoided by chamfering the tool exit side of the component.</li> </ul>

If our recommendations for optimizing are not successful, please don't hesitate to contact one of our applications engineers.

# TECHNOLOGICAL COMPARISON

## Thread Connection vs. Pokolm DUOPLUG® Connection

### WHERE THE DIFFERENCE IS:

**Pokolm Thread Connection –  
our high-performance standard**

**Pokolm Thread Connection**



This standard thread connection is produced with the best tolerances possible using the latest technology. We maximize the efficiency of our Pokolm thread connections by optimizing our design of arbors, adapters, and milling cutter bodies.

**Our patented protected DUOPLUG® System –  
the perfect increase**

**Pokolm DUOPLUG®=  
Shrink and Screw**



Our Pokolm **DUOPLUG®** system offers optimum rigidity and extremely high precision and concentricity. As a supplement to conventional thread connections, the retention and supporting forces between cutting tool and adapter act along the entire surface of the shrink fit and a large part of the shrink thread. For more information, please see the assembling and dismantling instructions for our **DUOPLUG®** system in the "Operation Data" chapter.

**The fact is:**

**DUOPLUG® perfects the thread connection by means of greatly increased retention forces, resulting in the highest possible precision for extremely slim dimensions.**

## Pokolm Thread Connection – our high-performance standard

### Performance

- ➔ no undercut, thus avoiding a rated break-point
- ➔ extremely precise fit zone and extremely precise flange contact surface
- ➔ better tensile strength and heat resistance because of the special materials and extra-hard coating
- ➔ for hundreds of tool changes
- ➔ optimized chamfers on arbors and adapters

### Your Advantages

- ➔ increased process reliability
- ➔ universally applicable for all roughing and finishing operations
- ➔ better fatigue strength and red hardness
- ➔ lower tool costs because of longer tool life
- ➔ considerable increase in stability because of larger flange contact surface

### Ideal Applications

- ➔ low-cost standard equipment for milling operations in shallow and medium-deep cavities
- ➔ especially for deep machining applications without vertical walls

## Our patent protected DUOPLUG® System – the perfect increase

### Performance

- ➔ maximum precision and concentricity
- ➔ optimum stability
- ➔ absolutely backlash-free class of fits by screwed connection
- ➔ extremely precise and consistent connection
- ➔ clearly increased retention forces compared to conventional thread connection
- ➔ better tensile strength and heat resistance because of special materials and extra-hard coating

### Your Advantages









- ➔ longer tool life
- ➔ absolutely minimal vibrations with long overhangs
- ➔ renders top precision in finishing operations
- ➔ increased availability of tool system and increased process reliability
- ➔ improved performance in roughing operations
- ➔ better fatigue strength and red hardness

### Ideal Applications

- ➔ for maximum precision in finishing operations
- ➔ roughing and finishing applications with long overhangs
- ➔ ideal for applications on vertical walls because of extremely slim arbor/adaptor system

# BALANCING

## Balance grades of Pokolm arbors and adapters

Kind of taper	SK/BT			HSK					
view									
size	30	40	50	32	40	50	63	80	100
form			all	all	all	all	all	all	all
grade level	2,5	6,3	16	2,5	2,5	2,5	2,5	6,3	6,3
rpm	30.000	18.000	8.000	30.000	30.000	30.000	25.000	12.000	12.000

Deviations from this chart are possible – please tell us what your requirements are.

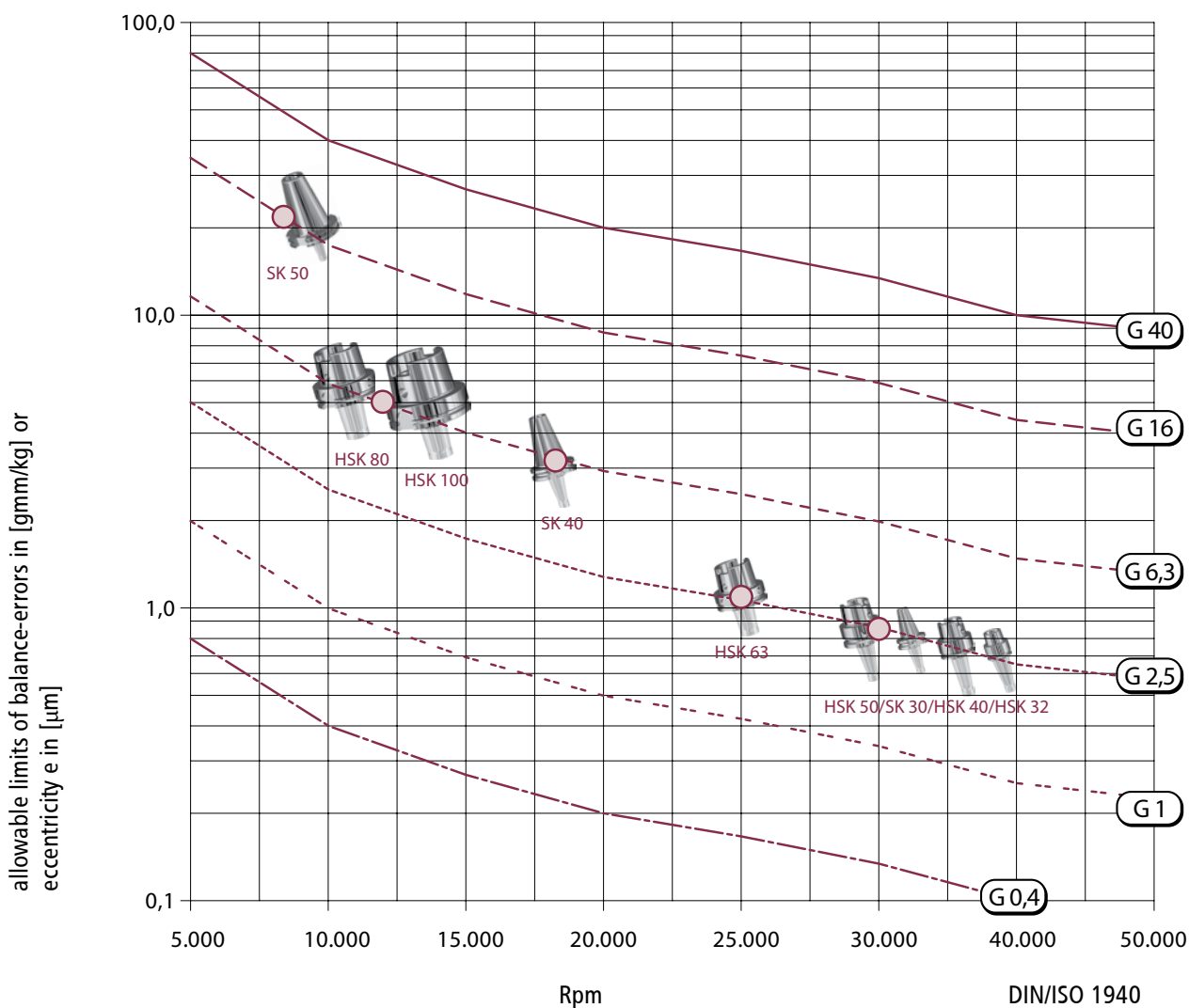

# CALCULATIONS AND DEFINITIONS

## Balancing grade classifications and typical applications:

- G 0,4** e.g. microfinishing machines
- G 1** e.g. low-power motors, driving gears for grinding machines
- G 2,5** e.g. cutting tools, small arbors and adapters, electrical motors, turbines
- G 6,3** e.g. cutting tools, arbors and adapters, machine tool parts
- G 16** e.g. big arbors, cardan shafts, drive shafts
- G 40** e.g. universal shafts, automotive wheels, crank gear drives

## Formulas:

Calculation of remaining balance error in [gmm/kg]	Calculation of radian frequency in [1/s]	Calculation of balancing grade levels in [mm/s]	Calculation of compensation mass
$e = \frac{U}{m}$	$\omega = \frac{2 \cdot \pi \cdot n}{60}$	$G = e \cdot \omega = \frac{U \cdot \pi \cdot n}{m \cdot 30}$	$m_r = \frac{e \cdot m}{r}$

## Definitions and dimensions:

- |   |  |
|---|--|
| <ul style="list-style-type: none"> <li><b>G</b> = balancing grade level in [mm/s]</li> <li><b>e</b> = remaining balance error in [gmm] or eccentricity of center in [μm]</li> <li><b>ω</b> = radian frequency (2 • π • f) in [1/s]</li> <li><b>f</b> = frequency (n/60) in [1/s]</li> <li><b>n</b> = rpm</li> </ul> | <ul style="list-style-type: none"> <li><b>U</b> = balance error [m • e] in [gmm]</li> <li><b>m</b> = rotor weight in [g]</li> <li><b>F</b> = centrifugal force (U • ω) in [N]</li> <li><b>r</b> = remaining balance error in [mm]</li> <li><b>m<sub>r</sub></b> = remaining balance error [g]</li> </ul> |
|---|--|



# BALANCE ERRORS AND BALANCING

## Definition of balance error



Rotational axis  $\neq$  mass axis  
 A balance error occurs when the rotational axis of a rotor part does not correspond to its mass axis.



Rotational axis = mass axis

## Reasons for Balance Errors:

- ⊕ Indexing seat for tool changer in SK and HSK
- ⊕ Driving slots in SK and BT
- ⊕ Driving slots in HSK- A, C, CE
- ⊕ any kinds of flats on tool shanks
- ⊕ Locking screws for tool shanks with flats
- ⊕ Non-uniform pitch on cutting tools
- ⊕ Collets and tightening nuts
- ⊕ Production tolerances

Balance errors can be eliminated either by adding material or by drilling corrective holes to remove material. See illustrations of corrective drill holes below:

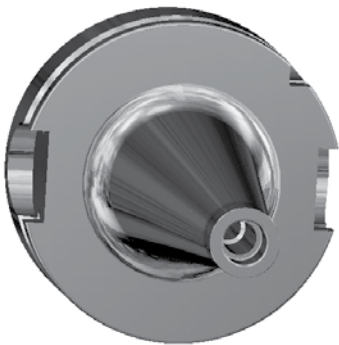

Unbalanced arbor

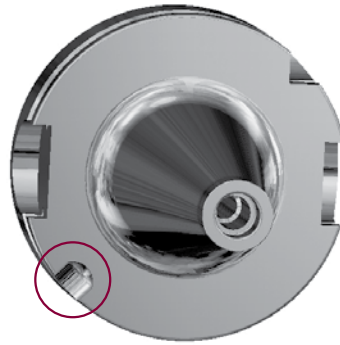

Balanced arbor with corrective drill hole



**➤** Balancing by drilling corrective holes. Sample calculations and detailed illustration, see next page.

## Example of a calculation:

Shrinking Arbor HSK 63A: 50 08 A63 S  
 weight: 760 grams  
 Taper radius: 31,5 mm  
 Balance grade: G 6.3 at 20,000 rpm

$$G = \frac{U \cdot 2 \cdot \pi \cdot n}{m \cdot 60} \Leftrightarrow U = \frac{G \cdot m \cdot 60}{2 \cdot \pi \cdot n}$$

$$U = \frac{6,3 \cdot 760 \cdot 60}{2 \cdot \pi \cdot 20.000} \Rightarrow U = 2,286 \text{ gmm}$$

$$e = \frac{2,286}{760} \Rightarrow e = 3 \mu\text{m}$$

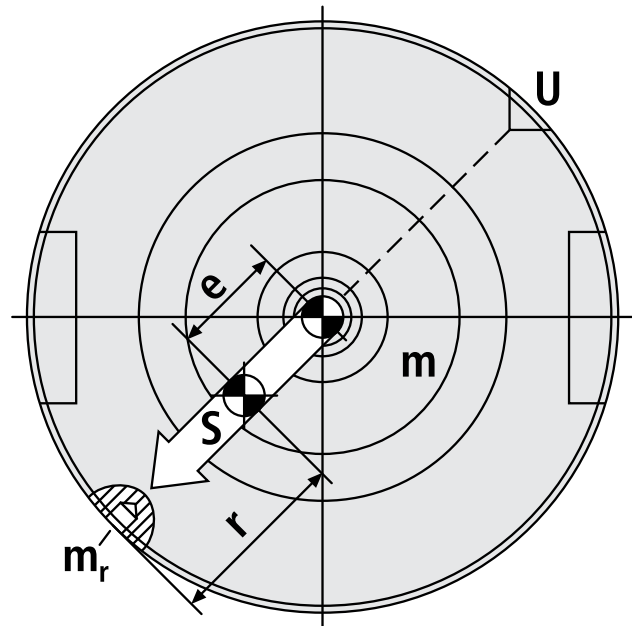

Note to illustration: "S" = mass axis

## Calculation of remaining balance error in example above:

$$m_r = \frac{m \cdot e}{r} \Rightarrow m_r = \frac{760 \cdot 0,003}{31,5} \Rightarrow m_r = 0,072\text{g}$$

By means of precision balancing, the remaining balancing error has been minimized to 0.072 g (in relation to the taper radius of the arbor of 31.5 mm).







## Your advantages – why this is such an important subject.









Balancing, particularly in connection with high concentricity, prevents your spindle from damage, because it decreases the centrifugal forces and reduces the formation of vibrations. This results in an extremely smooth operation, which greatly increases machining and component quality. In addition, it allows higher cutting parameters – both in high-speed milling and in conventional milling.

# THE POKOLM ARBOR SYSTEM

## The optimum solution for your application

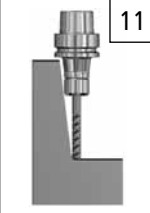
Arbor System	Advantages	Recommended applications
<p>ARBORS (TAPERED) for THREADED SHANK END MILLS</p>  <p>1</p>	<ul style="list-style-type: none"> <li>➤ rigid, low-cost standard design</li> <li>➤ large variety of types and lengths provides additional flexibility by using extensions and reductions</li> <li>➤ gaining rigidity by avoiding unnecessary interfaces</li> </ul>	<ul style="list-style-type: none"> <li>➤ milling in shallow to deep profiles, for small milling cutter bodies up to 42 mm diam.</li> </ul>
<p>ARBORS for THREAD-CONNECTIONS CYLINDRICAL</p>  <p>2</p>	<ul style="list-style-type: none"> <li>➤ slim shape</li> <li>➤ additional rigidity by avoiding unnecessary interfaces</li> <li>➤ where needed: additional flexibility with extensions and reductions</li> </ul>	<ul style="list-style-type: none"> <li>➤ medium machining depths, especially on deep vertical walls for small milling cutter bodies up to 42 mm diam.</li> </ul>
<p>REDUCTION SLEEVES with MORSE TAPER ADAPTERS</p>  <p>3</p>	<ul style="list-style-type: none"> <li>➤ Morse taper adapters for threaded shank end mill bodies and for shrinking processes available for solid carbide tools</li> <li>➤ fast and flexible tool change</li> <li>➤ modular design allows machining of deep slots and cavities</li> </ul>	<ul style="list-style-type: none"> <li>➤ for standard milling operations with normal rigidity and accuracy requirements, for milling cutter bodies up to 42 mm diam.</li> </ul>
<p>ARBORS for SHELL TYPE MILLING CUTTER BODIES</p>  <p>4</p>	<ul style="list-style-type: none"> <li>➤ rigid variant, in particular for roughing or pre-finishing operations with large cutter diameters and a large variety of designs</li> <li>➤ additional rigidity by avoiding unnecessary interfaces</li> </ul>	<ul style="list-style-type: none"> <li>➤ shallow to deep machining situations for pre-finishing and rough machining, for milling cutter diameters from 42 mm to 125 mm and larger</li> </ul>
<p>ARBORS with DIRECT SPINDLE MOUNTING</p>  <p>5</p>	<ul style="list-style-type: none"> <li>➤ extremely rigid style through direct spindle mounting</li> <li>➤ excellent machining conditions in deep slots or cavities</li> <li>➤ additional rigidity by avoiding interfaces</li> </ul>	<ul style="list-style-type: none"> <li>➤ deep and extremely deep machining situations on SK 50 machines which require extreme rigidity, for milling cutter diameters from 52 to 125 mm</li> </ul>
<p>SHRINKING ARBORS STANDARD STYLE</p>  <p>6</p>	<ul style="list-style-type: none"> <li>➤ slim style with 3° draft angle in direction of collar</li> <li>➤ direct shrink-grip of solid carbide tooling</li> <li>➤ additional rigidity by avoiding unnecessary interfaces</li> <li>➤ improved concentricity</li> <li>➤ combinable with solid carbide and dense antivibration adapters (see page 36-37)</li> </ul>	<ul style="list-style-type: none"> <li>➤ machining situations in narrow space conditions for solid carbide end mills up to 25 mm diam., and when combined with solid carbide or dense antivibration adapters even for milling cutter bodies with up to 42 mm diam.</li> </ul>

Arbor System	Advantages	Recommended Applications
SHRINKING ARBORS, REINFORCED DESIGN  	<ul style="list-style-type: none"> <li>➔ 4.5° draft angle, reinforced shank</li> <li>➔ direct shrink grip of solid carbide end mills</li> <li>➔ additional rigidity by avoiding unnecessary interfaces</li> <li>➔ improved concentricity</li> </ul>	<ul style="list-style-type: none"> <li>➔ milling with increased requirements for arbor rigidity for solid carbide end mills up to 20 mm diam.</li> </ul>
ARBOR COMBINATIONS with DUOPLUG® ADAPTERS  	<ul style="list-style-type: none"> <li>➔ extremely long and slim arbor combinations</li> <li>➔ greatest possible avoidance of vibrations by using solid carbide adapters</li> <li>➔ <b>DUOPLUG®</b> connection for maximum precision and concentricity</li> <li>➔ stronger retention forces</li> </ul>	<ul style="list-style-type: none"> <li>➔ machining in deep cavities also with vertical walls</li> <li>➔ roughing operations with maximum retention forces</li> <li>➔ finishing operations with very high requirements for surface finish</li> <li>➔ up to cutter diam. of 25 mm</li> </ul>
ARBOR COMBINATIONS with DENSE ANTI- VIBRATION ADAPTERS  	<ul style="list-style-type: none"> <li>➔ long and slim arbor combinations</li> <li>➔ minimal vibrations because of special dense antivibration material</li> <li>➔ thread connection, no shrinking process necessary</li> </ul>	<ul style="list-style-type: none"> <li>➔ machining in deep cavities also with vertical walls</li> <li>➔ for narrow and deep moulds and dies</li> <li>➔ machining applications with normal vibration tendency</li> <li>➔ for cutter diam. of up to 42 mm</li> </ul>
ZERO-REACH ARBORS  	<ul style="list-style-type: none"> <li>➔ by directly shrinking the solid carbide end mill or dense antivibration adaptor in the arbor taper, you can machine vertical walls right up to the arbor collar. This means great increase in rigidity because of the reduced distance between the spindle and tool.</li> </ul>	<ul style="list-style-type: none"> <li>➔ machining of extremely deep cavities with vertical walls in very limited space and with limited movement of Z-axis, and high requirements for rigidity and vibration-free milling</li> </ul>
ER20 PRECISION COLLET CHUCKS  	<ul style="list-style-type: none"> <li>➔ universal and good value solution, direct grip of solid carbide end mills via collet without a shrinking device</li> <li>➔ also grips unusual shank diameters and shank diameters smaller than 3 mm</li> </ul>	<ul style="list-style-type: none"> <li>➔ for fast changing applications</li> <li>➔ for finishing, pre-finishing, and moderate roughing operations</li> </ul>
ARBOR COMBINATIONS with SOLID CARBIDE ADAPTERS  	<ul style="list-style-type: none"> <li>➔ long and slim arbor combinations</li> <li>➔ minimal vibrations because of special solid carbide material</li> <li>➔ thread connection, no shrinking process necessary</li> </ul>	<ul style="list-style-type: none"> <li>➔ machining in deep cavities also with vertical walls</li> <li>➔ for narrow and deep moulds and dies</li> <li>➔ machining applications with normal vibration tendency</li> <li>➔ for cutter diam. of up to 42 mm</li> </ul>

Please note: Zero-reach arbors cannot be ordered separately. We only supply them in a shrink-grip connection with a solid carbide or dense antivibration adapter. (Please indicate desired adapter on purchase order form.)

# OUR POKOLM BAG OF TRICKS

## Shell-type Extensions

### Reduction adapters - shell type to thread connections

You have to machine an extensive deep component? The requested arbor-extension is not available as a standard item? The production of customized arbors is too expensive? There is no time left for any special action?

### SPECIAL SITUATIONS REQUIRE SPECIAL SOLUTIONS.

Our latest shell-type extensions and the thread-connections/shell-type combi adapters allow to achieve a possibility of assembling tool beyond our standard range.

1. an existing standard arbor has to be equipped with supplement bore holes according to our adjoining sketch.
2. screw on your selected adapter.
3. start your job.

THIS RESULTS IN EXTENSIONS BETWEEN 50 AND 100 MM

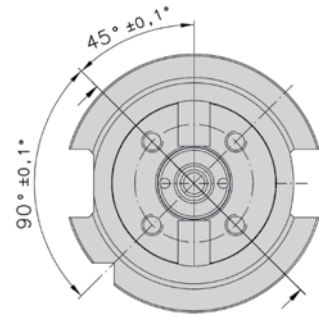
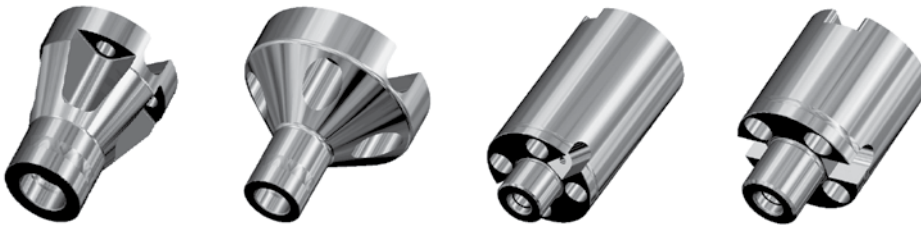

Extension - top view

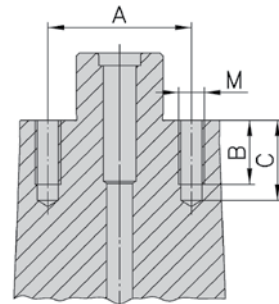

Extension - side view

Catalogue No.	Tool	Diameter of Spigot	Extensions length	A	B	C	Screws*
60 22 Mxx 783	Thread connection – Shell-type Combi Adapters	Ø 22	60	Ø 35	20	25	M 6 x 25
100 22 Mxx 783	Thread connection – Shell-type Combi Adapters	Ø 22	100	Ø 35	20	25	M 6 x 25
60 27 Mxx 783	Thread connection – Shell-type Combi Adapters	Ø 27	60	Ø 44,5	20	25	M 8 x 25
100 27 Mxx 783	Thread connection – Shell-type Combi Adapters	Ø 27	100	Ø 44,5	20	25	M 8 x 25
50 22 782	Shell-type Extensions	Ø 22	50	Ø 35	20	25	M 6 x 55
100 22 782	Shell-type Extensions	Ø 22	100	Ø 35	20	25	M 6 x 55
50 27 782	Shell-type Extensions	Ø 27	50	Ø 44,5	20	25	M 8 x 55
100 27 782	Shell-type Extensions	Ø 27	100	Ø 44,5	20	25	M 8 x 55

\*for fixing an adapter, you need 4 screws each, included in extent of supply.

# HSK FORMS AND DESIGNS

## Form A

Form A is automatically changeable via gripper groove (A) and index slots (B). The index slots provide a defined position for stopping the spindle. Drill hole (C) is for manual operation of gripping mechanism and central coolant supply.

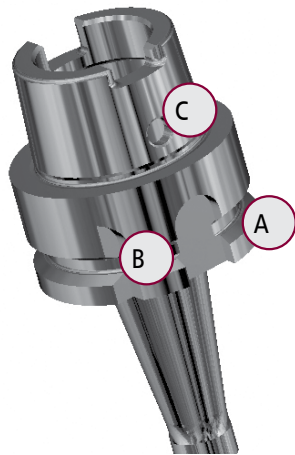

DIN 69 893-1

## Form E

Automatically changeable via gripper groove (A). Drill hole (C) for manual operation of gripping mechanism on request.

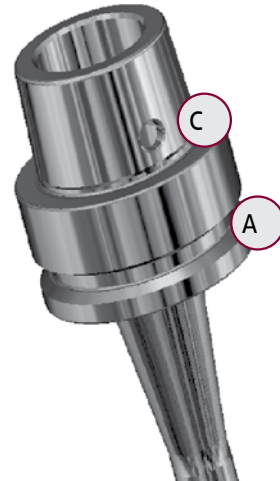

DIN 69 893-5

## Form EC

EC in its basic design conforms to form E. Additional driving slots (D) allow use in machining centres with a machine connection of forms C as well as E. Drill hole (C) for manual operation of gripping mechanism.

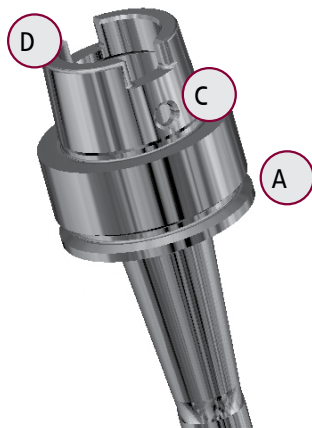

Based on  
DIN 69 893-5

## Form F

Automatically changeable via gripper groove (A). Drill hole (C) for manual operation of gripping mechanism. In order to secure a larger contact surface, the diameter of the tapered machine connection (E) is reduced in relation to the collar diameter (F).

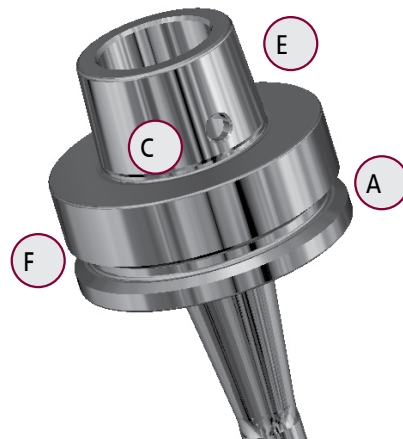

DIN 69 893-6



# STARTING TORQUES FOR TORX® SCREWS

with the Pokolm Torque Screwdriver



## Allowable starting torques for Torx® screws in the Pokolm range of accessories.

Thread	Torx® size	max. starting torque* [Nm]	recommended starting torque* [Nm]
M 1,8	T 6	0,4	0,28
M 2,0	T 6	0,62	0,43
M 2,5	T 7 / T 8	1,28	0,90
M 3,0	T 9 / T 10	2,25	1,57
M 3,5	T 10 / T 15	3,45	2,40
M 4	T 15	5,15	3,60
M 4,5	T 20	7,60	5,30
M 5	T 20	10,20	7,10

\* Starting torques apply to screws of strength category 12.9 and result in a load factor of 90% of yield point and are based on a mean friction coefficient of 0.14  $\mu\text{m}$ .

The new Pokolm torque screwdrivers let you adjust your required starting torque quickly and easily.

Our adjustable torque screwdrivers can be safely operated because of the easily readable scale. With interchangeable bits for universal use.

### Your advantage:

The defined and reproducible fixture of indexable inserts and clamping elements in our milling cutter bodies ensures optimum retention forces, thus preventing damage to milling cutters, inserts, and screws.

High Standard of Quality: Pokolm uses quality screws and screwdrivers made by leading manufacturers. They are optimally coordinated with the high-performance capability of our products. All accessories can be found on the following pages.

# HARDNESS CONVERSION TABLE

## Tensile Strength, Vickers-, Brinell- und Rockwell Hardness

Tensile Strength $R_m$ N/mm <sup>2</sup>	Vickers Hardness HV10	Brinell Hardness HB	Rockwell Hardness HRC
255	80	76,0	
270	85	80,7	
285	90	85,5	
305	95	90,2	
320	100	95,0	
335	105	99,8	
350	110	105	
370	115	109	
385	120	114	
400	125	119	
415	130	124	
430	135	128	
450	140	133	
465	145	138	
480	150	143	
495	155	147	
510	160	152	
530	165	156	
545	170	162	
560	175	166	
575	180	171	
595	185	176	
610	190	181	
625	195	185	
640	200	190	
660	205	195	
675	210	199	
690	215	204	
705	220	209	
720	225	214	
740	230	219	
755	235	223	
770	240	228	20,3
785	245	233	21,3
800	250	238	22,2
820	255	242	23,1
835	260	247	24,0
850	265	252	24,8
865	270	257	25,6
880	275	261	26,4
900	280	266	27,1
915	285	271	27,8
930	290	276	28,5
950	295	280	29,2
965	300	285	29,8
995	310	295	31,0
1030	320	304	32,2
1060	330	314	33,3
1095	340	323	34,4
1125	350	333	35,5

Tensile Strength $R_m$ N/mm <sup>2</sup>	Vickers Hardness HV10	Brinell Hardness HB	Rockwell Hardness HRC
1155	360	342	36,6
1190	370	352	37,7
1220	380	361	38,8
1255	390	371	39,8
1290	400	380	40,8
1320	410	390	41,8
1350	420	399	42,7
1385	430	409	43,6
1420	440	418	44,5
1455	450	428	45,3
1485	460	437	46,1
1520	470	447	46,9
1555	480	456*	47,7
1595	490	466*	48,4
1630	500	475*	49,1
1665	510	485*	49,8
1700	520	494*	50,5
1740	530	504*	51,1
1775	540	513*	51,7
1810	550	523*	52,3
1845	560	532*	53,0
1880	570	542*	53,6
1920	580	551*	54,1
1955	590	561*	54,7
1995	600	570*	55,2
2030	610	580*	55,7
2070	620	589*	56,3
2105	630	599*	56,8
2145	640	608*	57,3
2180	650	618*	57,8
	660		58,3
	670		58,8
	680		59,2
	690		59,7
	700		60,1
	720		61,0
	740		61,8
	760		62,5
	780		63,3
	800		64,0
	820		64,7
	840		65,3
	860		65,9
	880		66,4
	900		67,0
	920		67,5
	940		68,0

# MATERIAL GROUP CROSS REFERENCES

	M. No.	DIN	European Standard	France AFNOR	Great Britain BS	Japan JIS	Italia UNI	Sweden SS	Spain U.N.E./I.H.A	USA AISI/SAE	
Steel	Free Machining Steel/ Mild Steel	1.0037	St37-2	S235JR	E34-2	37/23 HR	SN 400 B	Fe 360 B FU	1311	AE 235 B	1015
		1.0044	St44-2	S275JR	E28-2	43/25 HR	SN 400 B	Fe 430 B FN	1412	AE 275 B	1020
		1.0050	St50-2G	E295	A50-2	4360	SS 490	Fe 490	1550/2172	A 490	-
		1.0070	St70-2G	E360	A70-2	4360	-	Fe 690	1655	A 690	-
		1.0570	St52-3	S355J2G3	E36-3	50/35 HR	SM490 A;B;C;YA;YB	Fe 510/Fe52B FN/Fe52 CFN	2132/2134	AE 355 D	1024
		1.1141	Ck15	C15E	XC 18	080 M 15	S15C	C16	1370	C15K	1015 / 1017
		1.1191	Ck45	C45E	XC 45	080 M 46	S45C	C45	1672	C45E	1042 / 1045
		1.1730	C45W	C45U	Y3 42 / Y3 48	EN 43 B	-	-	1672	F.114	1045
		1.7131	16MnCr5	16MnCr5	16 MC 5	527 M 17	-	16MnCr5	2173/2511	F.1516	5115 / 5117
	Normal Tool Steels/ Steel Castings	1.2067	100Cr6	102Cr6	Y100C6	BL 3	SUJ 2	-	-	100Cr6	L3
		1.2162	21MnCr5	21MnCr5	-	-	-	-	-	-	-
		1.2307	29CrMoV9	29CrMoV9	-	-	-	-	-	-	-
		1.2311	40CrMnMo7	35CrMo 8	-	-	-	35CrMo8KU	-	F.5263	P20
		1.2312	40CrMn MoS8-6	-	-	-	-	-	-	X210CrW12	P20+1
		1.2323	48CrMoV6-7	-	-	-	-	-	-	-	-
		1.2341	6CrMo15-5	5CrMo16	-	-	-	-	-	-	P4
		1.2343	X37CrMoV5-1	X37CrMoV5-1	Z38CDV5	BH 11	SKD 6	X37Cr MoV51KU	X37CrMo V5-1	X37Cr MoV5-1	H11
		1.2344	X40CrMoV5-1	X40CrMoV5-1	Z40CDV5	BH 13	SKD 61	X40CrMo V511KU	2242	X40Cr MoV5-1	H13
		1.2842	90MnCrV8	90MnCrV8	90MV 8	BO 2	-	90 MnCrV 8 KU	-	F.5229	O2
Tools Steels, Chrome-Nickel Alloys, Steel castings, difficult to machine	1.2080	X210Cr12	X210Cr12	Z200C12	BD 3	SKD 1	-	X210Cr12	X210Cr12	D3	
	1.2363	X100CrMoV5	X100CrMoV5	Z100CDV5	BA 2	SKD 12	X205 Cr12KU	2260	X100CrMoV5	A2	
	1.2369	81MoCr V42-16	-	-	-	-	X100CrMoV5 1KU	-	-	613	
	1.2379	X153CrMoV12	X153CrMoV12	Z 160 CDV 12	BD 2	SKD10/ SKD11	X155CrV Mo121KU	2310	X153CrMoV12	D2	
	1.2567	30WCrV17-2	X30WCrV53	-	-	SKD 4	-	-	-	-	
	1.2708	54NiCrMoS 6	-	-	-	-	-	-	-	-	
	1.2713	55NiCrMoV6	55 NiCrMoV 7	-	-	(SKT4)	-	-	F.520.S	L6	

		M.-No.	DIN	European Standard	France AFNOR	Großbritanni- en BS	Japan JIS	Italia UNI	Sweden SS	Spain U.N.E./I.H.A	USA AISI/SAE	
Steel	Tools Steels, Chrome-Ni- ckel Alloys, Steel castings	1.2738	40CrMnNi Mo8-6-4	40CrMnNi Mo8-6-4	-	-	-	-	-	-	-	
		1.2767	45NiCrMo16	45NiCrMo16	-	-	SKT 6	40NiCrMo V16KU	-	-	-	
		1.6358	XNiCo Mo18-9-5	-	-	-	-	-	-	-	-	
High-temperature Alloys	Heat-resistance Alloys	1.3401	X120Mn12	-	Z120M12	BW 10	SCMnH 1	G-X120Mn12	2183	F.8251	-	
		1.4865	GX40NiCr Si38-19	GX40NiCr Si38-19	GX40NiCr Si38-19	3330 C 11 / 331 C 40	SCH 15	GX40NiCr Si38-19	GX40NiCr Si38-19	GX40NiCr Si38-19	-	
		2.4375	NiCu30Al (Monel K-500)	-	(NU30AT)	NA 18	-	-	-	-	-	Monel K-500
		2.4610	NiMo16Cr16Ti (Almenit 4610)	-	-	NA 45	-	-	-	-	-	Hastelloy C-4
		2.4619	NiCr22Mo7Cu (Coralloy 4619)	-	-	-	-	-	-	-	-	Hastelloy G-3
		2.4631	NiCr20TiAl (Nimonic 80A)	Ni-P95-HAT (AECMA)	NC 20 TA	(ZHR201; HR401,601)	NCF 80A	-	-	-	-	Nimonic 80 A; HEV 5
		2.4636	NiCo15Cr15Mo AlTi (Dux 4636)	-	-	HR 4	-	-	-	-	-	Nimonic 115
		2.4648	EL-NiCr19Nb (FoxNibas 70/20)	-	-	-	-	-	-	-	-	-
		2.4668	NiCr19NbMo (Inconel 718)	NiCr19Fe19 Nb5Mo3	NC19FeNb	NiCr19Fe19 Nb5Mo3	NCF 718	NiCr19Fe19 Nb5Mo3	NiCr19Fe19 Nb5Mo3	NiCr19Fe19 Nb5Mo3	NiCr19Fe19 Nb5Mo3	Inconel 718 XEV-I
		2.4856	NiCr22Mo9Nb (Inconel 625)	NiCr22MO9Nb	NC22FeDNb	NA 43/Na 21	NCF 625	NiCr22MO9Nb	NiCr22MO9Nb	NiCr22MO9Nb	NiCr22MO9Nb	Inconel 625
	-	Ti99,5 HB 30-200	-	-	-	-	-	-	-	-	-	
	-	Ti99,6 HB 30-170	-	-	-	-	-	-	-	-	-	
	-	Ti99,7 HB 30-150	-	-	-	-	-	-	-	-	-	
	-	Ti99,8 HB 30-120	-	-	-	-	-	-	-	-	-	
	-	TiAl6V4ELI	-	-	TA11	-	-	-	-	-	AMS R56401	
	-	TiAl5Sn2.5	-	T-A5E	TA14/17	-	-	-	-	-	AMS 54520	
	3.7025	Ti 1	-	-	2 TA 1	-	-	-	-	-	AMS R50250	
	3.7124	TiCu2	-	-	2 TA21-24	-	-	-	-	-	-	
	3.7145	TiAl6Sn2 Zr4Mo2Si	-	-	-	-	-	-	-	-	AMS R54620	
	3.7165	TiAl6V4	-	T-A6V	TA10-13 / TA28	-	-	-	-	-	AMS R56400	
	3.7175	TiAl6V6Sn2	-	-	-	-	-	-	-	-	-	
	3.7184	TiAl4Mo4Sn2	-	-	-	-	-	-	-	-	-	
	3.7185	TiAl4Mo4Sn2	-	-	TA 45-51; TA57	-	-	-	-	-	-	
	3.7225	Ti 1 Pd	-	-	TP1	-	-	-	-	-	AMS 52250	

# MATERIAL GROUP CROSS REFERENCES (continued)

	M.-No.	DIN	European Standard	France AFNOR	Great Britain BS	Japan JIS	Italia UNI	Sweden SS	Spain U.N.E./I.H.A	USA AISI/SAE	
Stainless Steel	all sorts	1.2316	X36CrMo17	X38CrMo16	Z38CD16-01	X38CrMo16	-	X38CrMo16	-	F.5267	-
		1.2367	X38CrMoV5-3	X38CrMoV5-3	Z38CDV5-3	X38CrMoV5-3	-	X38CrMoV5-3	X38CrMoV5-3	X38CrMoV5-3	-
		1.3543	X102CrMo17	X108CrMo17	Z100CD17	X108CrMo17	SUS 440C	X105CrMo17	X108CrMo17	F.3425	440 C
		1.4059	GX22CrNi17	-	Z20CN 17.2M	ANC 2	-	-	-	-	-
		1.4122	GX35CrMo17	X39CrMo17-1	Z38CD 16.1CI	X39CrMo17-1	-	X39CrMo17-1	X39CrMo17-1	X39CrMo17-1	-
		1.4301	X5CrNi18-10	X5CrNi18-10	Z6CN18.09	304 S 15	SUS 304	X5CrNi1810	2332	F.3504	304
		1.4305	X12CrNiS18-8	X8CrNiS18-9	Z8CNF18-09	303 S 31	SUS 303	X10CrNiS18-9	2346	F.310.C	303
		1.4340	GX40CrNi27-4	-	-	-	-	G X 35 CrNi 28 05	-	-	-
		1.4401	X5CrNiMo 17-12-2	X5CrNiMo 17-12-2	Z7CND 17-11-02	316 S 33	SUS 316	X5CrNiMo 17 12	2347	F.3534	316
		1.4462	X2CrNiMoN 22-5-3	X2CrNiMoN 22-5-3	Z2CND 22-06-03	318 S 13	SUS 329J3L	X2CrNiMoN 22-5-3	2377	X2CrNiMoN 22-5-3	S31803/ S32205
		1.4541	X10CrNiTi18-9	X6CrNiTi18-10	Z6CNT 18-10	321 S 31	SUS 321	X6CrNiTi18-10	2337	F.3523	321
		1.4551	X10CrNi 18-9	X5CrNiNb 20 10 KE	Z6CNNb 20-10	-	SUS Y 374	-	-	-	-
		1.4571	X10CrNiMo Ti18-10	X6CrNiMo Ti17-12-2	Z6 CNDT 17-12	320 S 31	SUS 316Ti	X6CrNiMo Ti17-12	2350	F.3535	316Ti
		1.4712	X10CrSi6	-	-	-	-	-	-	-	-
		1.4742	X10CrAl18	X10CrSi18	Z10CAS18	430 S 15	SUS 430	X8Cr17	-	F.3113	430
Cast Iron	Grey Cast Iron	0.6010	GG10	EN-GJL-100	Ft10D	GRADE100	FC 10	G10	0110-00	FG 10	NO 20 B
		0.6020	GG20	EN-GJL-200	Ft20D	GRADE200	FC 20	G20	0120-00	FG 20	No 30 B
		0.6030	GG30	EN-GJL-300	Ft30D	GRADE300	FC 30	G30	0130-00	FG 30	No 45 B
		0.6040	GG40	EN-GJL-350	Ft35D	GRADE350	FC 35	G35	0135-00	FG 35	-
	Spheroidal Graphite	0.7040	GGG-40	EN-GJS-400-15	FGS 400-12	SNG 420/12	FCD 400	GS 400/12	07 17-02	FGE 38-17	60-40-18
		0.7050	GGG-50	EN-GJS-500-7	FGS 500-7	SNG 500/7	FCD 500	GS 500/7	07 27-02	FGD 50-7	65-45-12
		0.7060	GGG-60	EN-GJS-600-3	FGS 600-7	SNG 600/3	FCD 600	GS 600/3	07 32-03	FGE 60-2	80-55-06
		0.7070	GGG-70	EN-GJS-700-2U	FGS 700-2	SNG 700/2	FCD 700	GS 700/2	07 37-01	FGS 70-2	100-70-03
	0.7080	GGG-80	E8N-GJS-800-2	FGS 800-2	SNG 800/2	FCD 800	GS 800/2	-	-	120-90-02	
	Tempered Castings	GTS 35-10	EN-GJMB-350-10	MN 35-10	B 340/12	-	-	08 15	-	32510	-
		GTS 45-06	EN-GJMB-450-6	-	P 440/7	-	-	08 52	-	40010	-
		GTS 55-04	EN-GJMB-550-4	MP 50-5	P 510/4	-	-	08 54	-	50005	-
GTS 65-02		EN-GJMB-650-2	MP 60-3	P 570/3	-	-	08 85	-	70003	-	

		M.-No.	DIN	European Standard	France AFNOR	Great Britain BS	Japan JIS	Italia UNI	Sweden SS	Spain U.N.E./I.H.A	USA AISI/SAE
Non-ferrous Materials	Aluminum	3.0255	Al99.5	EN-AW-1050A	A59050C	L31/L34/L36	-	-	-	-	1000
		3.1325	AlCuMg1	EN-AW-2017A	-	-	-	-	-	-	-
		3.2163	G-AlSi9Cu3	EN-AC-46200	-	-	-	-	-	-	-
		3.2315	AlMgSi1	EN-AW-6082	-	-	-	-	-	-	-
		3.2383	G-AlSi10Mg	-	-	LM 9	-	-	4253	-	A 360.2
		3.2581	G-AlSi12	EN-AW-2017A	-	LM 6	-	-	4261	-	A 413.2
		3.3535	AlMg3	EN-AW-5754	-	-	-	-	-	-	-
		3.4345	AlZnMgCu0,5	EN-AW-7022	AZ4GU/9051	L 86	-	-	-	-	7050
		3.5105	GMgZn4 SE1Zr1	-	G-Z4TR	MAG 5	-	-	-	-	ZE 41
		3.5812	G-MgAl8Zn1	-	G-A9	MAG 1	-	-	-	-	AZ 81
	Copper	-	CuMn5F36	-	-	-	-	-	-	-	-
		-	CuSi2MnF34	-	-	-	-	-	-	-	-
		-	E-Cu57	-	-	-	-	-	-	-	-
		-	CuZn15	-	CuZn 15	CZ 102	-	-	-	-	C 23000
		-	CuZn30	-	CuZn 30	CZ 106	-	-	-	-	C 26000
		-	CuZn37	-	CuZn 37	CZ 108	-	C2720	-	-	C 27700
		-	CuZn36Pb3	-	-	-	-	-	-	-	-
		-	G-CuZn34Al2	-	U-Z36N 3	HTB 1	-	-	-	-	C 86200
		-	G-CuSn5ZnPb	-	U-E5Pb5Z5	LG 2	-	-	-	-	C 83600
		-	G-CuPb10Sn	-	U-E10Pb10	LB 2	-	-	-	-	C 93700
		-	CuCrZr	-	U-Cr 0,8 Zr	CC 102	-	-	-	-	C 18200
		Graphite	-	ISO-63	-	-	-	-	-	-	-
	-		ISO-90	-	-	-	-	-	-	-	-
	-		ISO-93	-	-	-	-	-	-	-	-
	-		ISO-95	-	-	-	-	-	-	-	-
	Plastics	-	Ureol® 5211 A/B	-	-	-	-	-	-	-	-
		-	Ureol® 5212 A/B	-	-	-	-	-	-	-	-
		-	Ureol® 5213 A/B	-	-	-	-	-	-	-	-
		-	Ureol® 5214 A/B	-	-	-	-	-	-	-	-
		-	Ureol® 5215 A/B	-	-	-	-	-	-	-	-
		-	Ureol® 5216 A/B	-	-	-	-	-	-	-	-
		-	Ureol® 5217 A/B	-	-	-	-	-	-	-	-
		-	Ureol® 5218 A/B	-	-	-	-	-	-	-	-
-		Ureol® 5219 A/B	-	-	-	-	-	-	-	-	



# MATERIAL GROUP CROSS REFERENCES (continued)

	M.-No.	DIN	European Standard	France AFNOR	Great Britain BS	Japan JIS	Italia UNI	Sweden SS	Spain U.N.E./I.H.A	USA AISI/SAE	
Hardened Steel	up to 48HRC	1.2311	40CrMnMo7	35CrMo 8	-	-	-	35CrMo 8 KU	-	-	-
		1.2312	40CrMn-MoS8-6	-	-	-	-	-	-	-	-
		1.2323	48CrMoV6-7	-	-	-	-	-	-	-	-
		1.2343	X38CrMoV5-1	X37CrMoV5-1	Z38CDV 5	BH 11	SKD 6	X37CrMoV51 KUa	X37CrMoV5-1	F.520.G	H 11
		1.2344	X40CrMoV51	X40CrMoV5-1	Z40CDV 5	BH 13	SKD 61	X40CrMoV 5 1 1 KU	2242	X40CrMoV 5-1	H 13
		1.2708	54NiCrMoS6	-	-	-	-	-	-	-	-
		1.2842	90MnCrV8	90MnCrV8	90Mv8	BO 2	-	90MnVCr 8 KU	90MnCrV8	F.5229	O 2
	up to 55HRC	1.2080	X210Cr12	X210Cr12	Z200C12	BD 3	SKD 1	X210Cr12	X210Cr12	F.521	D 3
		1.2323	48CrMoV6-7	-	-	-	-	-	-	-	-
		1.2344	X40CrMoV5-1	X40CrMoV5-1	Z40CDV5	BH 13	SKD 61	X40CrMoV5-1	2242	X40CrMoV5-1	H 13
		1.2363	X100CrMoV51	X100CrMoV5	Z100CDV5	BA 2	SKD 12	X100CrMoV5	2260	X100CrMoV5	A 2
		1.2369	81MoCrV 42-16	-	-	-	-	-	-	-	613
		1.2379	X155CrV-Mo12-1	X153CrMoV12	Z160CDV12	BD 2	SKD 11	X153CrMoV12	2310	X153CrMoV12	D 2
		1.2567	30WCrV17-2	X30WCrV53	-	-	SKD 4	-	-	-	-
		1.2708	54NiCrMoS6	-	-	-	-	-	-	-	-
		1.2713	55NiCrMoV6	55NiCrMoV7	55NCDV7	-	SKT 4	-	-	F.520.S	L 6
		1.2738	40CrMnNi Mo8-6-4	40CrMnNi Mo8-6-4	40CrMnNi Mo8-6-4	40CrMnNi Mo8-6-4	40CrMnNi Mo8-6-4	40CrMnNi Mo8-6-4	40CrMnNi Mo8-6-4	40CrMnNi Mo8-6-4	40CrMnNi Mo8-6-4
		1.2767	X45NiCrMo4	45NiCrMo16	45NiCrMo16	45NiCrMo16	SKT 6	45NiCrMo16	45NiCrMo16	45NiCrMo16	-
1.2842	90MnCrV8	90MnCrV8	90MnCrV8	BO 2	-	90MnCrV8	90MnCrV8	90MnCrV8	O 2		
up to 65HRC	1.2080	X210Cr12	X210Cr12	Z200C12	BD 3	SKD 1	X210Cr12	X210Cr12	X210Cr12	D 3	
	1.2363	X100CrMoV5	X100CrMoV5	Z100CDV5	BA 2	SKD 12	X100CrMoV5	2260	X100CrMoV5	A 2	
	1.2369	81MoCrV 42-16	-	-	-	-	-	-	-	613	
	1.2379	X153CrMoV12	X153CrMoV12	Z160CDV12	BD 2	SKD 10	X153CrMoC12	2310	X153CrMoC12	D 2	
	1.2767	45NiCrMo16	45NiCrMo16	45NiCrMo16	45NiCrMo16	SKT 6	45NiCrMo16	45NiCrMo16	45NiCrMo16	-	
	1.2842	90MnCrV8	90MnCrV8	90MnCrV8	BO 2	-	90MnCrV8	90MnCrV8	90MnCrV8	O2	

# FORMULAS AND CALCULATION EXAMPLES

Formulas			
<p>Calculation of revolutions of main spindle in [min-1]:*</p> $n = \frac{V_c \cdot 1000}{\pi \cdot D_{c/eff}}$	<p>Calculation of feed per tooth in [mm/tooth]:</p> $f_z = \frac{V_f}{n \cdot z}$	<p>Calculation of feed per min. in [mm/min.]:</p> $V_f = n \cdot z \cdot f_z$	<p>Calculation of power requirement in [kW]:*</p> $P = \frac{a_e \cdot a_p \cdot V_f}{18000}$
<p>Calculation of cutting speed in [m/min]:*</p> $V_c = \frac{\pi \cdot D_{c/eff} \cdot n}{1000}$ <p>* Please note: For flat contours use true mill diameter to calculate cutting speed (see Surface Finish section).</p>	<p>Calculation of machining time in [min]:</p> $f_n = z \cdot f_z$ $f_n = \frac{V_f}{n}$	<p>Calculation of machining time in [min]:</p> $T = \frac{l_f}{V_f}$	<p>Calculation of chip volume in [cm3/min]:</p> $Q = \frac{a_e \cdot a_p \cdot V_f}{1000}$ <p>* Please note: The formula given for calculating the power requirement is valid for machining steel only.</p>
Definitions:			
<p><math>a_e</math> width of cut [mm]  <math>a_p</math> depth of cut in [mm]  <math>D_c</math> cutter diameter in [mm]</p>	<p><math>D_{c/eff}</math> true tool diameter in [mm]  <math>f_z</math> feed per tooth in [mm]  <math>l_f</math> milling length in [mm]  <math>f_n</math> feed per revolution in [mm/U]</p>	<p><math>n</math> revolution in [rpm]  <math>P</math> power requirement in [kW]  <math>Q</math> chip volume in [cm3/min]  <math>T</math> machining time in [min]</p>	<p><math>V_c</math> cutting speed in [m/min]  <math>V_f</math> feed per min. in [mm/min]  <math>z</math> no. of effective teeth</p>

formulas for calculating the true mill diameter can be found in the Surface Finish selection.

Calculation Example	
<p><b>Milling cutter:</b> 35200</p> <p><b>Selected insert:</b> 03 12 840K (see Cutting Material p. 421) (P40, PVTi coated)</p> <p><b>Size of insert:</b> Ø 12 x 3,97 mm</p> <p><b>Milling cutter diam.:</b> 35 mm</p> <p><b>no. of effective teeth:</b> 3</p> <p><b>Depth of cut:</b> 1,5 mm (see Operation Data Table)</p> <p><b>Width of cut:</b> 25 mm</p> <p><b>Material to be machined:</b> 1.1730, roughing</p> <p><b>Selected cutting speed:</b> <math>V_c = 250</math> m/min (see Operation Data pp. 392, 393, 408)</p> <p><b>Selected feed per tooth:</b> <math>f_z = 0,6</math> mm (see Operation Data pp. 394-401 + 410-417)</p>	<p><b>Calculation of revolutions</b></p> $n = \frac{250 \cdot 1000}{\pi \cdot 35} = 2275 \text{ U/min}$ <p><b>Calculation of feed per min.:</b></p> $V_f = 2275 \cdot 3 \cdot 0,6 = 4095 \text{ mm/min}$ <p><b>Calculation of chip volume:</b></p> $Q = \frac{(25 \cdot 1,5 \cdot 4095)}{1000} = 154 \text{ cm}^3/\text{min}$ <p><b>Calculation of power requirement:</b></p> $P = \frac{(25 \cdot 1,5 \cdot 4095)}{18000} = 8,5 \text{ kW}$

# CLASSIFICATION OF CARBIDE MATERIAL GRADES INDEXABLE INSERTS FOR MILLING

Designation of main groups of chip removal and groups of application according to ISO 513

DESIGNATION	RANGE OF APPLICATION											MATERIAL TO BE MACHINED					
	1	5	10	15	20	25	30	35	40	45	50	P Steel	M Stainless	K Cast-Iron	N Non-ferrous materials	S High-tempera- ture alloys	H Hardened Steel
CBN Steel	[Shaded]											[Shaded]					
BN-K10			[Pentagon]														[Major]
CBN Cast Iron	[Shaded]											[Shaded]					
BN-K20					[Pentagon]								[Major]				
HSC 05 PVTi	[Shaded]											[Shaded]					
HC-P10			[Pentagon]									[Major]					
HC-K05			[Pentagon]										[Major]	[Minor]			[Major]
HSC 05 PVFN	[Shaded]											[Shaded]					
HC-P10			[Pentagon]									[Major]					
HC-K05			[Pentagon]										[Major]	[Minor]			[Major]
K 10	[Shaded]											[Shaded]					
HW-M15				[Pentagon]									[Minor]				
HW-K10			[Pentagon]											[Minor]			
K10 PVTi	[Shaded]											[Shaded]					
HC-M15			[Pentagon]										[Minor]			[Minor]	
HC-K10			[Pentagon]										[Major]	[Minor]			[Minor]
P25 PVGO	[Shaded]											[Shaded]					
HC-P25					[Pentagon]							[Minor]					
HC-M25						[Pentagon]							[Minor]			[Minor]	
P25 PVTi	[Shaded]											[Shaded]					
HC-P25					[Pentagon]							[Major]					
HC-K20					[Pentagon]									[Major]			
P40 PVTi	[Shaded]											[Shaded]					
HC-P40						[Pentagon]						[Major]					
P40 PVGO	[Shaded]											[Shaded]					
HC-P35						[Pentagon]						[Major]					
HC-M35							[Pentagon]						[Minor]				
HC-K30							[Pentagon]							[Major]			
P40 PVSR	[Shaded]											[Shaded]					
HC-P30						[Pentagon]						[Major]					
HC-K25							[Pentagon]							[Major]			[Minor]
P40 PVML	[Shaded]											[Shaded]					
HC-P35						[Pentagon]						[Major]					
HC-M35							[Pentagon]						[Minor]				
M40 PVST	[Shaded]											[Shaded]					
HC-P40							[Pentagon]					[Major]					
HC-M40								[Pentagon]					[Minor]			[Minor]	

German standard designation

- Major application
- Minor application

Full colour circle symbols represent: Major applications for materials to be machined.  
 Hollow colour circle symbols represent: Minor applications for materials to be machined.  
 The upper point of the pentagon-symbol indicates major applications. Sloping sides to the right or left indicate minor applications.

# DIAGRAM WEAR RESISTANCE

For classification of the main carbide grades for milling according to its wear resistance and toughness

This diagram shows the ratio of wear resistance to toughness of our main carbide grades for milling applications. It displays extended operative ranges, shows possibilities of supplementary use and alternatives of main grades in case of different kinds of tool wear. It also illustrates the multiplicity of the operative range.

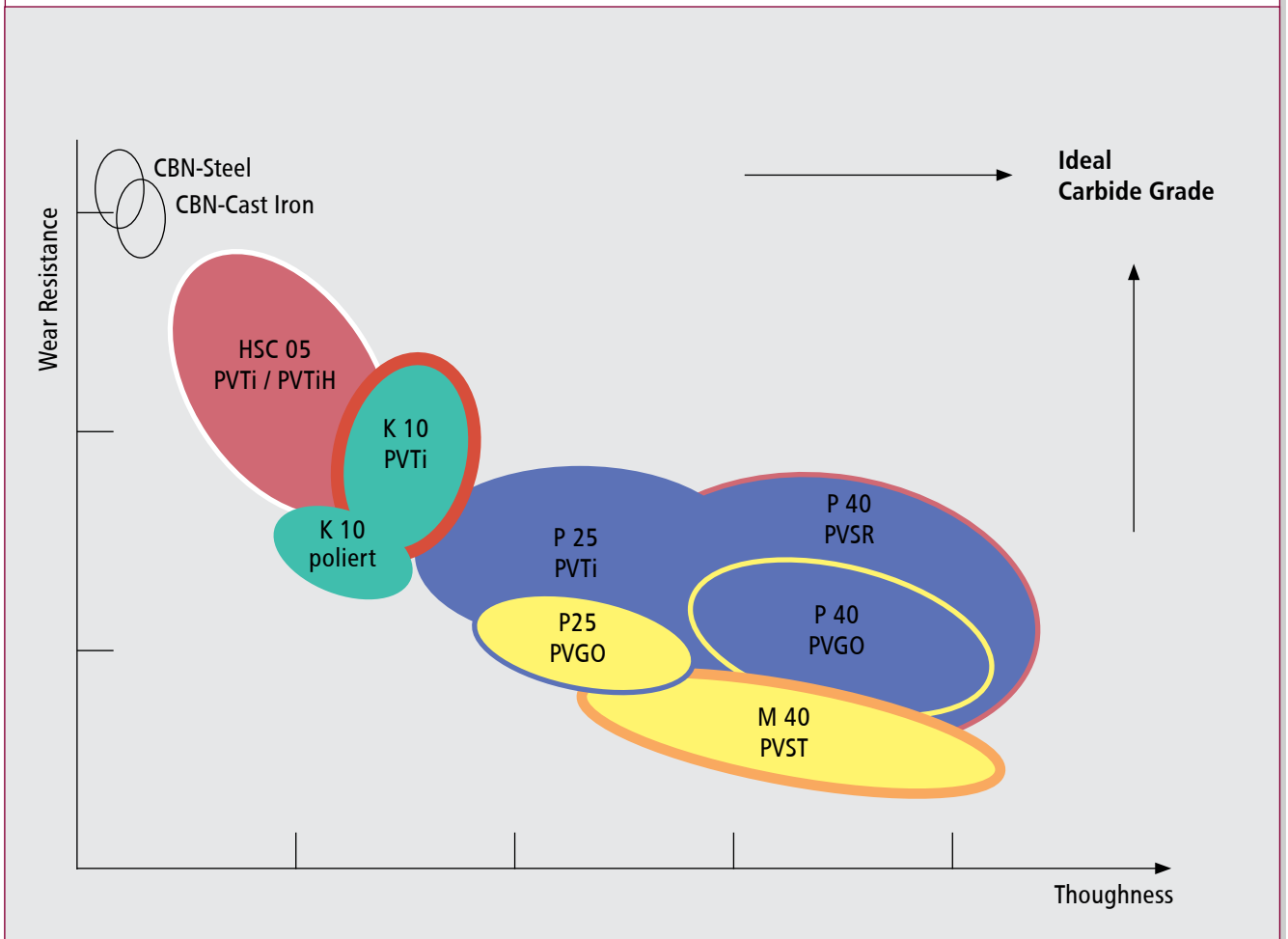

# IDENTIFICATION CODE ACCORDING ISO 1832

## INDEXABLE INSERTS

Example of identification code according to DIN ISO 1832

# R

# D

# H

# X

1

2

3

4

### Shape

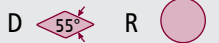
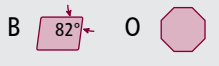

### Clearance angle

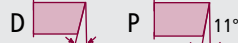
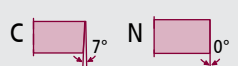

O for other clearance angles that require a more precise description

### Tolerances

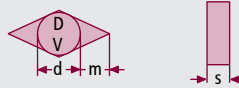
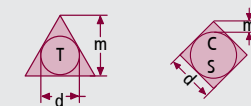

	d	m	s
A	± 0,025	± 0,005	± 0,025
C	± 0,025	± 0,013	± 0,025
E	± 0,025	± 0,025	± 0,025
F	± 0,013	± 0,005	± 0,025
G	± 0,025	± 0,025	± 0,05-0,13
H	± 0,013	± 0,013	± 0,025
J1	± 0,05-0,15 <sup>2</sup>	± 0,005	± 0,025
K1	± 0,05-0,15 <sup>2</sup>	± 0,013	± 0,025
L1	± 0,05-0,15 <sup>2</sup>	± 0,025	± 0,025
M	± 0,05-0,15 <sup>2</sup>	± 0,02-0,08 <sup>2</sup>	± 0,05-0,13
N	± 0,05-0,15 <sup>2</sup>	± 0,02-0,08 <sup>2</sup>	± 0,025
U	± 0,08-0,15 <sup>2</sup>	± 0,13-0,38 <sup>2</sup>	± 0,13

<sup>1</sup> inserts with ground wiper edges  
<sup>2</sup> depending on size of inserts (see ISO-Norm 1832)

### Symbols for fixing and chipbreakers

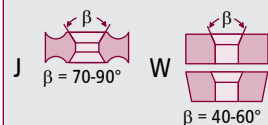
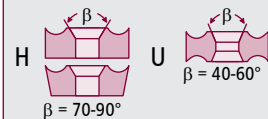
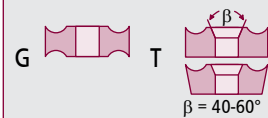
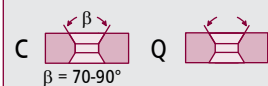
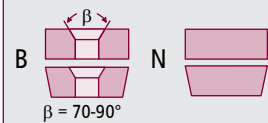

X dimensions or characteristics requiring precise descriptions

# 16 04 M0 T N -

5	6	7	8	9	10
<p><b>Length of cutting edge</b></p>	<p><b>Thickness</b></p> <p>           s = 1,59 01            s = 1,98 T1            s = 2,38 02            s = 2,78 T2            s = 3,18 03            s = 3,97 T3            s = 4,76 04            s = 5,56 05            s = 6,35 06            s = 7,94 07            s = 9,52 09         </p>	<p><b>Corner configuration</b></p> <p>           r = 0,2 02            r = 0,4 04            r = 0,8 08            r = 1,2 12            r = 1,6 16            r = 2,4 24         </p> <p><b>Clearance angle on wiper edge</b></p> <p>           A = 3°            B = 5°            C = 7°            D = 15°            E = 20°            F = 25°            G = 30°            N = 0°            P = 11°         </p> <p>Z = other clearance angle</p> <p>           00 for diameters in the imperial system converted to mm.            M0 for diameters in the metric system.         </p> <p><b>Rake angle <math>\chi_r</math></b></p> <p>           A = 45°            D = 60°            E = 75°            F = 85°            P = 90°         </p> <p>Z = other clearance angle</p>	<p><b>Cutting edge shape</b></p>	<p><b>Advance feed</b></p>	<p><b>Special code for manuf.</b></p> <p>One or two-digit codes (numbers or letters) are selected by manufacturer. They must be separated from the prior codes by a hyphen (-).</p>

for 5+6 Figures after the comma are to be disregarded. In the case of a one-digit code, a lead "0" must be added (e.g. the code for 4.76 mm is 04).  
 for 8+9 Codes 8 and/or 9 are used only if required.



# COATING SUMMARY

## Inserts

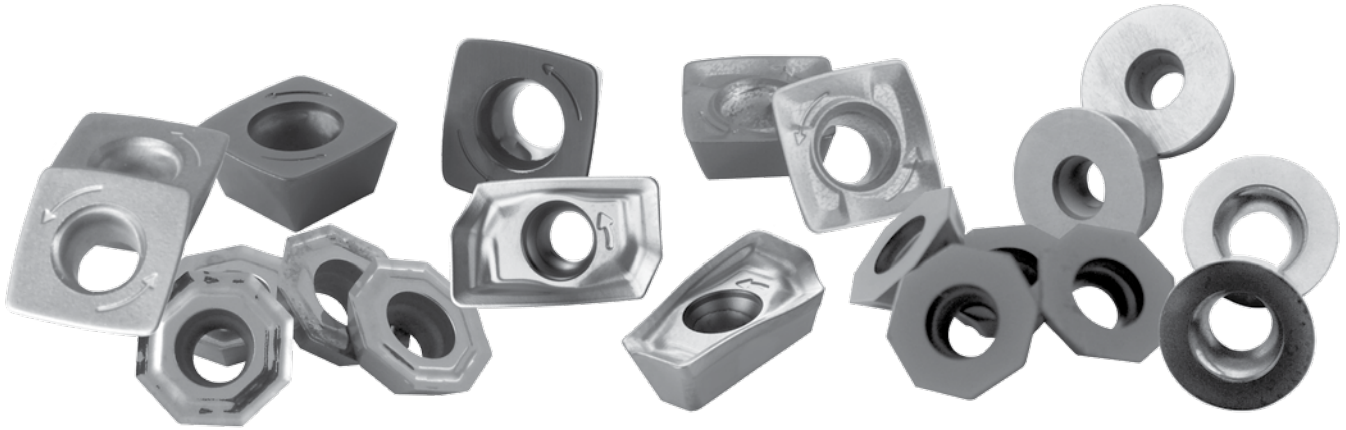

Description		Colour	Vickers Hardness HV	Maximum Temperature in Centigrade	Type of Coating	Thickness of Coating in $\mu\text{m}$
PVTi	TiAlN	blue/grey	3600	up to 850°	PVD	2 to 4
PVDiaN	Diamond-coating, normal	dull grey	10000	up to 600°	CVD	6 to 8
PVSR	-	black	1420 HV30	up to 1000°	CVD	4 to 6,5
PVGM	-	gold	1280 HV30	up to 650°	CVD	2 to 3,5
PVML	TiAlSiN	gold	3300	800° to 850°	PVD	2,5 to 5
PVFN	PVFN	blue/grey	3300	up to 950°	PVD	2 to 4
PVGO	TiAlN + TiN	yellow/gold	3150	900°	PVD	2 to 4,5
PVTiH	TiAlN Multilayer	violet/brown	3600	up to 1100°	PVD	4 to 5
PVST	AlTiN	blue/grey	3300	up to 950°	PVD	2 to 4

# CUTTING MATERIALS

Material	Coatings	Material						
		Steel	High-temperature Alloys	Stainless Steel	Cast Iron	Non-ferrous Materials	Hardened Steel	
P40	PVTi							Coated very tough standard carbide grade for roughing of steel with medium surface speed and increased tool life.
P40	PVGO							Coated, very tough high performance special carbide grade for pre-finishing and roughing steel, suitable for medium up to high speed values, partial suitable for cutting cast iron and stainless steel.
P40	PVSR							Coated extremely tough special carbide grade for pre-finishing and roughing of steel, with medium surface speed and extremely high feed rates.
P40	PVGM							Coated very tough high performance special carbide grade for pre-finishing and roughing of stainless steel, high temperature alloys and titanium.
P40	PVML							Coated, tough special carbide grade for pre-finishing and roughing steel at medium and high cutting speeds; in part suitable for finishing and for cast iron and stainless steel machining.
P25	PVTi							Coated tough standard carbide grade for pre-finishing and finishing of steel with medium and higher cutting speed and increased tool life.
K10	poliert							Uncoated standard carbide grade for medium surface speed for milling of cast iron, non-ferrous-materials and graphite.
K10	PVTi							Coated standard carbide grade for medium surface speed for milling of cast iron, non-ferrous-materials and graphite and increased tool life.
K10	PVDiaN							Diamond-coated standard carbide grade for high-speed finishing of non-ferrous-materials and graphite.
K05	PVTi							Coated standard carbide grade for finishing of steel, hardened steel and steel castings with increased surface speed.
HSC05	PVTi PVTiH							Coated high performance special carbide grade for high-speed finishing of steel, hardened steel and steel castings as well as graphite and plastics.
HSC05	PVFN							Extremely wear resistant special carbide grade for cutting steel, hardened steel and cast iron suitable for high- and very high-speed applications.
CBN C								CBN-grade for high-speed finishing of cast iron.
CBN S								CBN-grade for high speed finishing of hardened steel over 48 HRC.
PKD								Universal PKD-grade for high speed finishing of non-ferrous-materials and plastics.

# ASSEMBLING INSTRUCTIONS

## DUOPLUG®

To guarantee optimum results and safe operation of our **DUOPLUG®** system, please follow the instructions below carefully.

### Assembling:

#### Preparations

Get all the accessories and equipment ready at the workstation before starting heating procedure! (appropriate spanner, safety glasses, protective gloves)

#### Step 4

Inductive heating expands the fitted bore in the cutter body. Only then can you totally screw the body onto the end face of your adaptor with the appropriate spanner. This step must be possible without using too much strength. If there is still some resistance, please heat the **DUOPLUG®** cutter body once more for a few seconds and try again.



#### Step 1

Remove inserts and their screws from the milling cutter body.

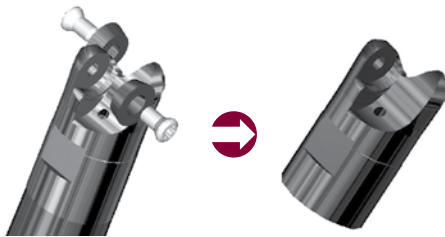

#### Step 5

Make sure that the body and adaptor fit together perfectly. There should be no gap.

**Perform these steps with only moderate strength.**



#### Step 2

 **Attention:** All surfaces carrying special fits must be absolutely grease-free and dust-free. Please screw the **DUOPLUG®** milling cutter body onto the **DUOPLUG®** adaptor by hand up to the fit zone. Do not use a tool or too much strength.



#### Step 6

Do not shock cool your shrunk combination; use the air-cooling equipment of your Shrinking Unit TSI 3510 to cool it evenly. During cooling, the **DUOPLUG®** cutter body contracts and you get a safe load transmission.



#### Step 3

Heat this connection now with the Pokolm Inductive Shrinking Unit TSI 3510 for 6 to 15 seconds, depending on diameter, then start Step 4 immediately.

**Attention:** Adaptor and milling cutter body are very hot after this process! Danger of burning hands or fingers! Protective gloves **MUST** be worn!



#### Step 7

Mount the desired inserts onto the body with their screws. After checking the diameter and length of your tool, you can start your operation.

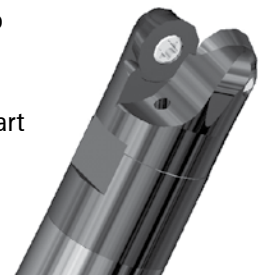

## Dismantling:

### Preparations

Get all the necessary accessories and equipment together at the workstation before starting heating procedure! (appropriate spanner, safety glasses, protective gloves)



Attention: You absolutely **MUST** wear your safety glasses when dismantling! Used tools carry swarf and cooling fluid residues which could spray out during operation!

### Step 3

Inductive heating expands the fitted bore in your cutter body. Only after heating should you unscrew your cutter body from your adaptor using an appropriate spanner. This step must be possible to perform without strength. If there is still some resistance, please heat the cutter body once more for a few seconds and try again.



### Step 1

Remove inserts and screws from milling cutter body.

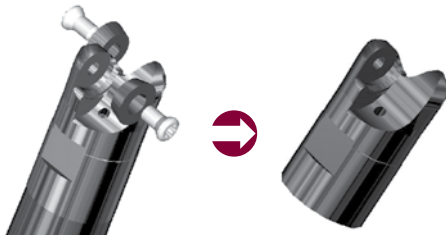

### Step 4

Do not shock cool your unshrunk dismantled parts; use the air-cooling equipment of your shrinking unit TSI 3510 to cool it slowly, or use the deposit box.



Attention: Adaptor and milling cutter body are still very hot! Danger of burning hands or fingers! Protective gloves **MUST** be worn!

### Step 2

Heat your used combination with the Pokolm Inductive Shrinking Unit TSI 3510 for 6 to 15 seconds, depending on diameter.



Attention: Adaptor and milling cutter body are still very hot!

Danger of burning hands or fingers! Protective gloves **MUST** be worn!



For further inquiries concerning the DUOPLUG® system, please do not hesitate to contact us.

# ASSEMBLING INSTRUCTIONS

## Seal ring for CNC precision drill chuck

Two seal rings for different drill diameters are generally included in the scope of delivery of all Pokolm CNC precision drill chucks. Please observe the instructions when exchanging the seal rings or replacing them with a corresponding spare part.

### Disassembly:

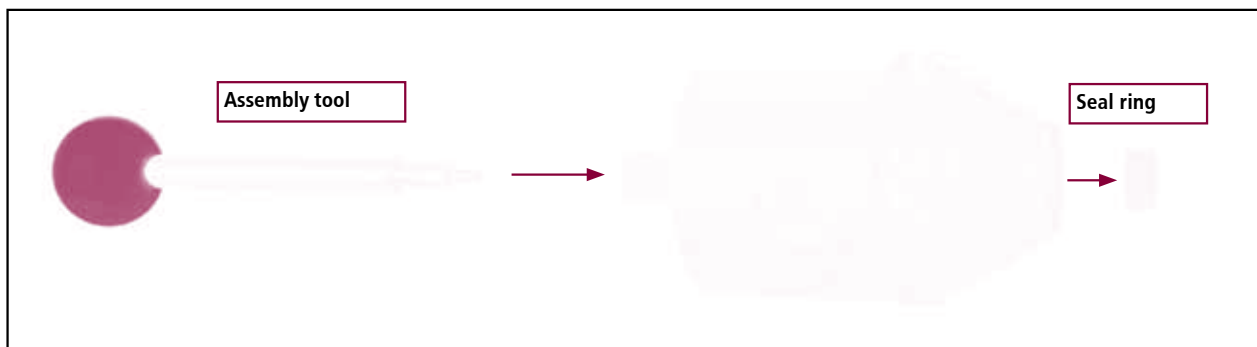

#### Step 1

Open the clamping jaws of the drill chuck with an Allen key. Dismantle the drill chuck on the machine side until the spindle can be freely accessed.

#### Step 2

Insert the assembly tool in the middle of the drill chuck on the side of the spindle until it meets resistance from the seal ring. By applying light pressure the seal ring can now be removed by pushing it forward and out through the clamping jaws.

### Assembly:

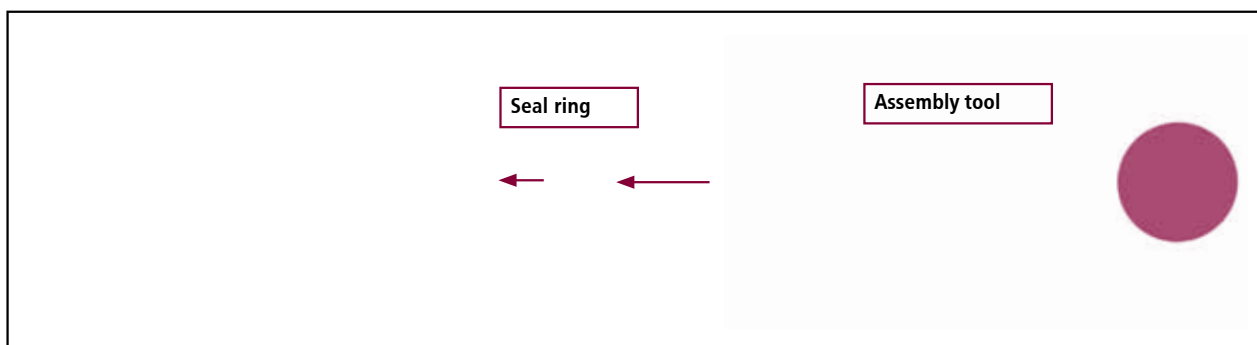

#### Step 1

Place the new seal ring with the hollow side facing the tool onto the assembly tool and insert from the front through the clamping jaw up to the seat of the seal ring. The seal ring is held in place with an O-ring.

# ASSEMBLING INSTRUCTIONS

## Centering arbor and flange contact surface

In order to ensure a trouble-free insertion into the machine during centering and screwing-on the flange contact surface make sure that the centering arbor and the flange contact surface are not screwed together tightly. The fastening screw that is provided is constructed in such a way that it prevents the centering arbor and the flange contact surface from becoming tightly screwed together.

Please observe the following instructions:

### Assembly of the centering arbor:

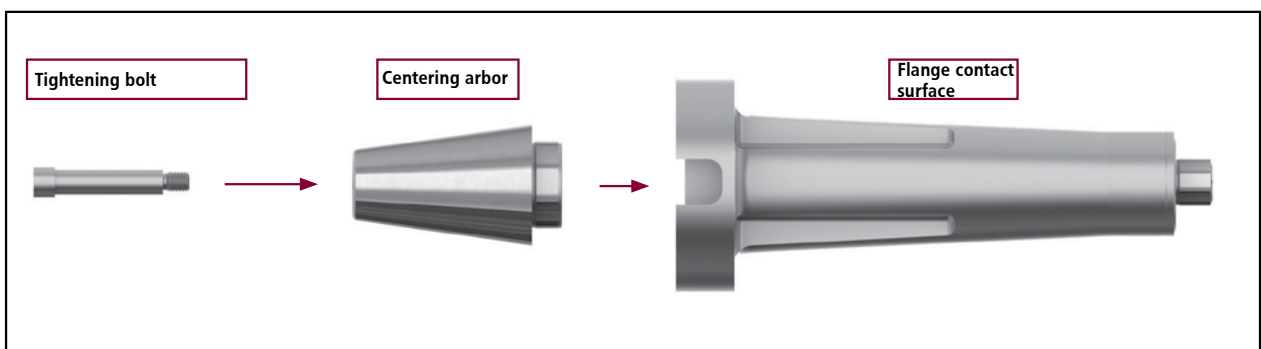

#### Step 1

Insert the centering arbor into the corresponding fitting of the flange contact surface.

#### Step 2

Insert the tightening bolt that is provided into the centering arbor and screw into the threading of the flange contact surface with an Allen key (10 mm) and then tighten by hand. Now the centering arbor and the flange contact surface are connected to each other.

### Assembly of the retaining bolt:

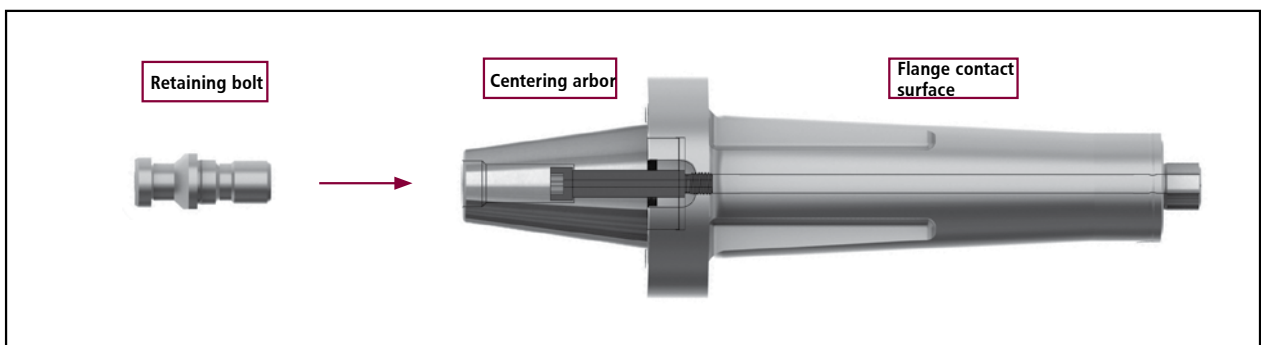

#### Step 1

Screw the retaining bolt into the inside thread of the centering arbor and tighten by hand. The flange contact surface can now be inserted and screwed to the machine.

# ASSEMBLING INSTRUCTIONS

## for Coolant supply tubes for HSK Form A

When using HSK-A arbors with internal coolant supply, it is necessary to assemble these arbors with a coolant supply tube. To assemble, please follow the instructions below. The required accessories are mentioned for every arbor size.

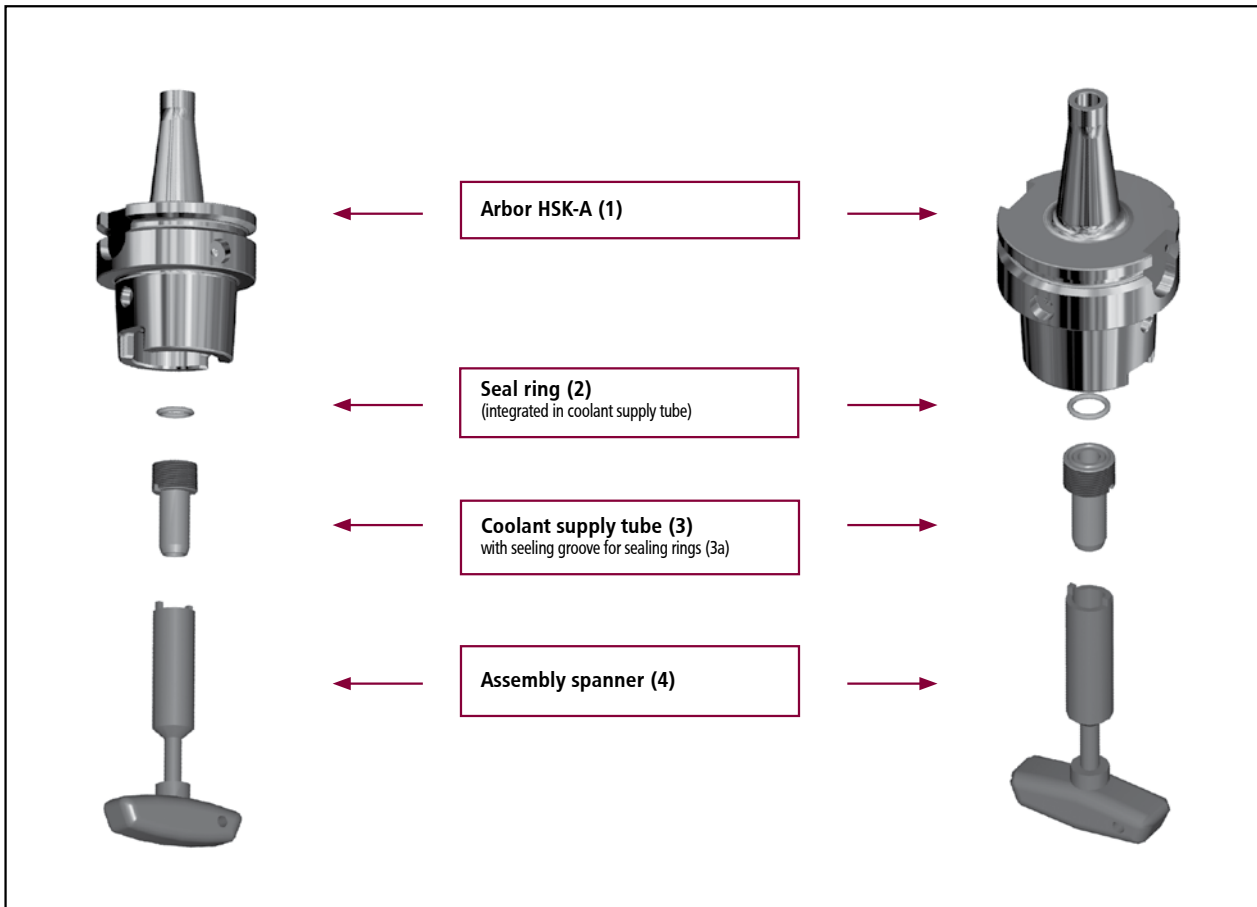

### Step 1

Usually, the seal ring (2) is already assembled in the coolant supply tube (3). If it has come loose, please put it back to the sealing groove (3a) of the supply tube (3).

### Step 2

Insert the narrow end of the tube (3) into the spanner (4).

### Step 3

Screw the tube (3) into the arbor (1) from the bottom up and make sure that the seal ring (2) is not off-centre or squeezed. Otherwise it loses its sealing function.



# ASSEMBLING INSTRUCTIONS

## for Milling cutter bodies with round inserts and shim

In order to maintain optimum and safe use of these tools, you should pay attention to following notice:

### Assembling Indexable Inserts

#### Step 1.1

Remove Torx-screw (5) from cutter body (1) with Torx-screwdriver (7) and check correct fit of threaded bush (3) in threaded bore (A), using provided Allen-key (4).

#### Step 1.2

Pay attention, that the shoulder of the threaded bush (3) sinks completely into the recess of the shim (2). If not, please fix it with the Allen-key (4).

#### Step 1.3

Assemble indexable inserts (8) first by means of Torx-screw (5), using Torx-screwdriver (7) and fasten finally with the locking screw (6) in threaded bore (B).

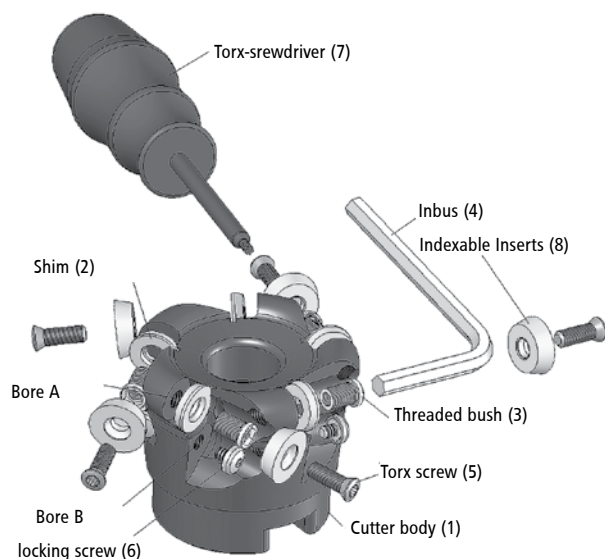

### Replace Shim

#### Step 2.1

For replacing shim, please prepare for Torx-screwdriver (7) and Allen-key (4).

#### Step 2.2

Unscrew locking screw (6) in threaded bore (B) and after that Torx-screws (5) fixing inserts (8) with Torx-screwdriver (7).

#### Step 2.3

Using Allen-key (4), unscrew and remove threaded bush (3) from threaded bore (A). Remove shim (2) from cutter body (1). Clean insert seat from swarf and grease, before you put new shims back to cutter body.

#### Step 2.4

Put new shims (2) into insert seats and fix it into threaded bore (A) with threaded bush (3) using Allen-key (4) and copper paste from our accessories selection. Pay attention, that the shoulder of the threaded bush (3) sinks completely into the recess of the shims (2).

#### Step 2.5

Now, indexable inserts (8) can be fixed as usually, using Torx-screws (5) and Torx-screwdriver (7). Finally, fasten locking screw (6) for secure insert fixing into threaded bore (B).

# ASSEMBLING INSTRUCTIONS

## Fitting of SPINWORX® inserts in the tool

In order to maintain optimum and safe use of these tools, you should pay attention to following notice:

### Step 1: placing inserts into the seat

Place the inserts (1) into the seat provided. Apply the paste included (4) to the thread of the pin (2) and make sure no paste (catalogue number „Z 00043“) gets onto the contact surface. Remove any surplus before using the tool.

### Step 2: inserting the pin

Insert the pin (2) into the screw attachment from behind and use the torque key to tighten according to the specified tightening torque. We recommend using the pre-set torque key with the catalogue number „T10-1,4 NM“.

### Tightening torques

Insert	Torx´ size	Tightening torque
DR10-8 DR12-8	T10	1.4 Nm

### CAUTION! Please note!

#### SIMPLE HANDLING THANKS TO CONVENIENT TOOL

We recommend our torque key „T10-1.4 NM“ with pre-set tightening torque as a convenient and safe alternative to conventional Torx or torque keys.



For optimum results with the SPINWORX®-tooling system we recommend using internal coolant supply air, emulsion or MMS for chip removal in the tool!

Wet machining up to max speed Vc of 140 m/min!

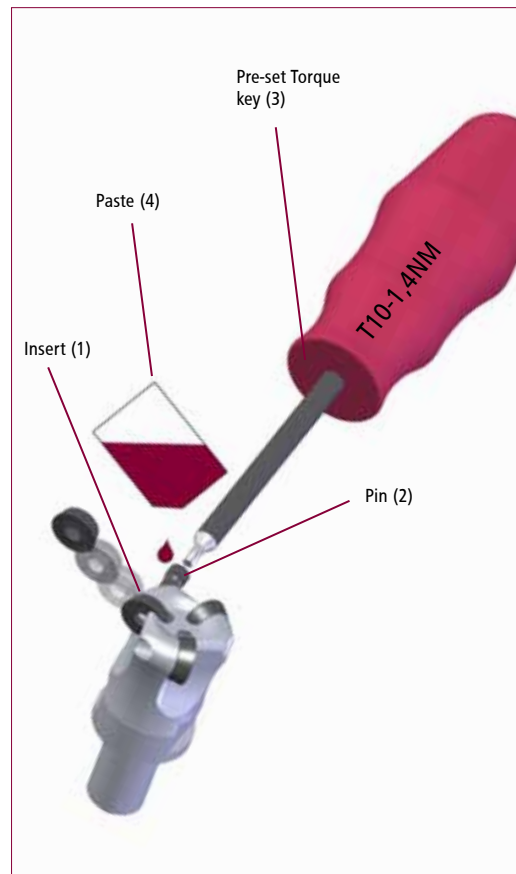

# ASSEMBLING INSTRUCTIONS

## Set-screw for shell type milling cutter bodies diam. 40 up to 42 mm

In order to maintain optimum and safe use of these tools, you should pay attention to following notice if you assemble set-screws GWSTPS81SK:

Assembling set-screw:

### Step 1

Screw set-screw into cutter body up to limit-stop contact. This is guaranteed for every tool in Pokolm's warehouse. In rare exceptional cases, this set-screw can become unfastened during transport. In that case, the set-screw has to be re-adjusted prior to usage.

### Step 2

For assembling, put milling cutter body on to arbor. Make sure, there is a remaining gap of 4 mm between milling cutter body and arbor. (this is guaranteed, when using genuine Pokolm-arbors).

### Step 3

Now, please screw the set-screw into the arbor uniformly, until there is no remaining gap between arbor and milling cutter body by using an Allen-key 5 mm opening.

### Step 4

If, beyond expectations, a gap remains, please dismantle your cutter body from the arbor. Unscrew the set-screw by ½ revolution. Continue with step 2.



**Please consider:**  
Maximum torque = 10 Nm

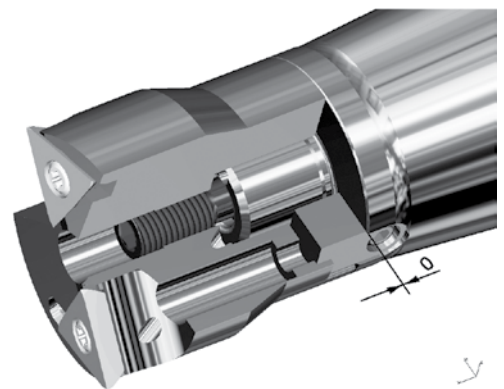
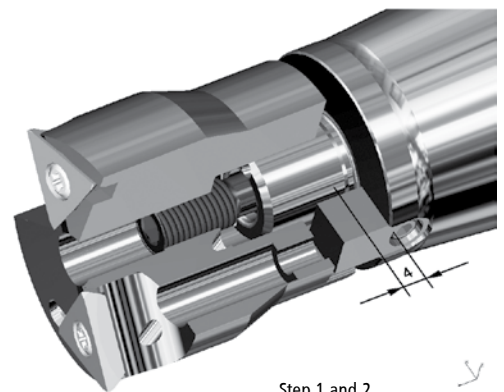

If you have any further question regarding milling systems with set-screw please do not hesitate to contact us.

## CUSTOMIZED PRODUCTS



**Milling Cutter Bodies**

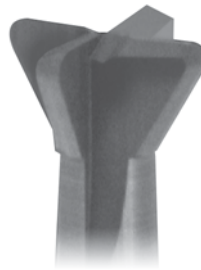

**Solid Carbide End Mills**



**Arbor Systems**

### State-of-the-Art –Our Customized Tool Offer

Many products in the Pokolm range originated as a response to individual customer demands and have been enhanced into successful standard products by consistent development. Meanwhile, Pokolm can provide you with tools and arbors, which are precisely coordinated with each other, and which can be combined in over 500,000 different ways to meet almost any demand for efficient milling. In our experience, about 90% of all milling applications in tool and mould-making can be completed using tools from this comprehensive standard range.

In addition, we produce customized tools and arbors for your special requirements according to your needs.

- ⊕ fast
- ⊕ reliable
- ⊕ on schedule

### And always precisely coordinated with all the other components in the Pokolm tool system.

Use the already prepared inquiry forms on the following pages for your individual inquiry or purchase order. Certainly, you can also download these forms at any time from our web-site: [www.pokolm.com](http://www.pokolm.com) as a PDF-file.

Or visit our website [www.sonderwerkzeuge.de](http://www.sonderwerkzeuge.de), which offers a comprehensive overview of all available customized products. Here you can find many solutions immediately with a simple mouse click, and often avoid special new productions.

# REFURBISHING OF PREMIUM SOLID CARBIDE END MILLS

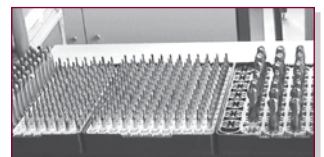

**Premium solid carbide tools live longer:  
... in more ways than one!**

The Pokolm-service team offers within this Workout-program for existing, already used Solid carbide tooling a wide variety of services:

- ⊕ reproduction
- ⊕ refurbishing
- ⊕ modification
- ⊕ recoating

We check, classify and mark every single tool individually, in order to ensure, that every customer receives his own tools back.

WORKOUT offers this service for all genuine Pokolm-tooling and also for non-Pokolm-tools, if its quality allows this.

You can send your tools for refurbishing, using the code "Workout" at any time to the following address:

**Pokolm  
Frästechnik GmbH**

Adam-Opel-Straße 5  
33428 Harsewinkel  
Germany

fon: +49 5247 9361-0  
fax: +49 5247 9361-99

E-Mail: [info@pokolm.com](mailto:info@pokolm.com)  
Internet: [www.pokolm.com](http://www.pokolm.com)



# HIGH-SPEED SPINDLE SYSTEMS

## MODERN SPINDLE UNITS FOR EFFECTIVE MILLINGS RESULTS

Many milling machines – both old and new – have a relatively low maximum speed. Low maximum speed does have advantages in roughing operations, but are a big drawback for achieving effective feed rates. Low speed also greatly limits the advantages of modern CNC applications. The results: much longer machining times and loss of valuable production capacities.

We offer a convincing solution for this situation: Pokolm high-speed spindle systems for the most profitable machining results.

## BETTER SURFACE FINISH RESULTS AND GREATLY IMPROVED CYCLE TIME

The advantages are impressive: higher cutting speeds, utilization of maximum feed rates – even with the smallest end mills – better surface finish and a great reduction in the need for EDM. Results: much shorter machining times and full utilization of the CNC advantages.

Pokolm provides various spindle systems for individual adaptation to existing machines and operation requirements. Operating with an approach angle of these spindles in A and C direction by using our swivel device, increases the variety of applications of your milling machine.

Get the maximum speed from your machines with Pokolm-spindle systems. The result: You save time!

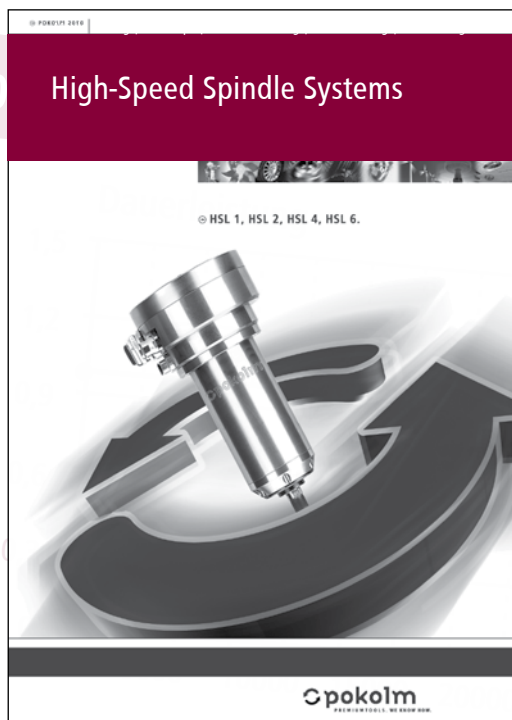

Ask our service centre about spindles:

- ⊕ spare parts
- ⊕ repairs
- ⊕ inspection
- ⊕ maintenance
- ⊕ swivel devices
- ⊕ CNC machine connection

Please contact us!

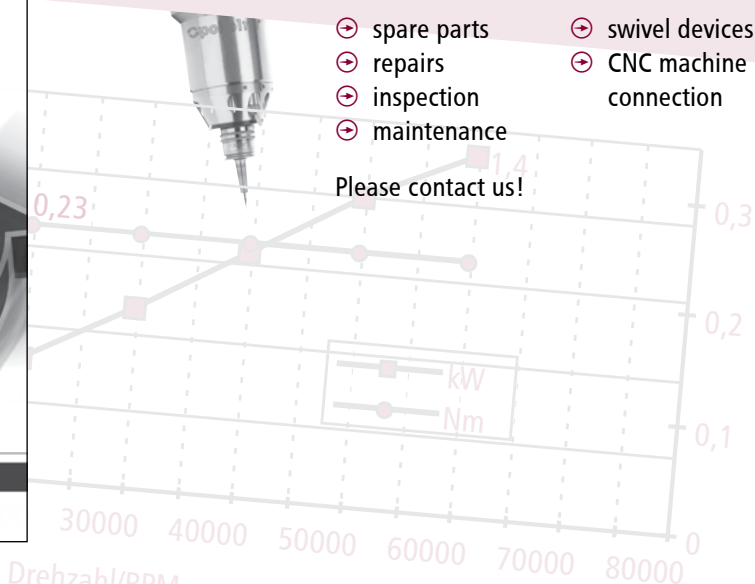

6000

kW

Drehzahl/min



# INDUCTIVE SHRINKING TECHNOLOGY

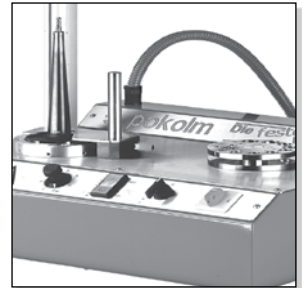

## FIRST OPERATION: SHRINKING, THEN MILLING

Shrinking Technology convinces everybody compared with conventional chucking methods from the past. What counts? Absolute concentricity and highest precision with extensive extended tool life. Shrinking technology offers a safe friction-locked connection between tool and tool holder and provides an increased transferable torque. And the qualification for maximum revolutions is the best precondition for an optimum surface finish and for reducing costs for expensive finishing processes.

Compared to conventional milling chucks, shrinking arbors allow the use of distinctly slim adaptors for machining components with narrow situations, which would be unexecutable with other tool-holding systems.

Pokolm offers a substantial range of tooling for shrinking technology: several top-class Induction Shrinking Units, shrinking arbors for all possible machine connections and our patent-protected connection system **DUOPLUG®** in combination with our "zero-reach"-shrinking arbors. (Additional information about the Pokolm **DUOPLUG®** System can be found under chapter "Milling Cutter Bodies" of this catalogue.)



# TEST REPORT OF MILLING CONDITIONS

Company: \_\_\_\_\_  
 Street: \_\_\_\_\_  
 City: \_\_\_\_\_  
 Contact: \_\_\_\_\_  
 Machine: HP: [kW]  
 Type: n(s): [min-1]  
 Arbor System:  $V_f$ : [mm/min]

Material No.:						Date:					
DIN Code:						Analysis [%]					
C	Si	Mn	P	S	Cr	Ni	Mo	V	W		
N/mm <sup>2</sup>			HB			HV			HRC		

CNC Control: \_\_\_\_\_

	Test	Actual Status	Test 1	Test 2	Test 3
Tool	Milling conditions				
	Manufacturer				
	Type				
	Arbor				
	Overhang				
	Kind of cooling (air / water?)				
Cutting Mater.	Kind				
	Manufacturer				
	Cutting Material Code				
	Coating				
Operation Data	$V_c$ [m/min]				
	$V_f$ [mm/min]				
	n(s) [min <sup>-1</sup> ]				
	$D_c$ [mm]				
	$f_z$ [mm/Zahn]				
	$a_p$ [mm]				
	$a_e$ [mm]				
	T [min]				
Results	No. of tests				
	Tool life [min]				
	Life in length [m]				
	Chip volume [cm <sup>3</sup> /min]				
	Energy consumption [kW]				
	Performance Evaluation:	1 2 3 4 5 6 7 8 9 10	1 2 3 4 5 6 7 8 9 10	1 2 3 4 5 6 7 8 9 10	1 2 3 4 5 6 7 8 9 10

Illustration / Remarks:

# PURCHASE/INQUIRY FORM

## Customized Solid Carbide/CBN and PKD Tools



Please fax to:

**+49 5247 9361-99**

(please copy prior to completion)

Inquiry No./P.O. No.:		Date:
Company:		
Address:		
Department:	person in charge:	
Phone:	Fax:	Email:
<input type="text"/> Requested delivery date		

We adapt our basic substrate and coating optimally to your requirements and to the material to be machined. Please mark any special requirements:

**Solid Carbide:**

- |                              |                              |                              |
|------------------------------|------------------------------|------------------------------|
| <input type="checkbox"/> KAC | <input type="checkbox"/> CBN | <input type="checkbox"/> UMG |
| <input type="checkbox"/> MGC | <input type="checkbox"/> PKD |                              |

left-hand cutting

**Shank Style DIN 6535:**

- Form HA (plain)
- Form HB (with clamping flats)
- Qty. required

**Coating:**

- |                                 |                                       |
|---------------------------------|---------------------------------------|
| <input type="checkbox"/> PVAT   | <input type="checkbox"/> PVCS         |
| <input type="checkbox"/> PVAS   | <input type="checkbox"/> PVALSA       |
| <input type="checkbox"/> PVCC   | <input type="checkbox"/> PVTi         |
| <input type="checkbox"/> PVCN   | <input type="checkbox"/> PVDiaN       |
| <input type="checkbox"/> PVDiaG | <input type="checkbox"/> PVTiH        |
|                                 | <input type="checkbox"/> Other: _____ |

**Material to be machined:**

**Further details:**

- |   |   |
|---|---|
| <input type="checkbox"/> No. of teeth   | <input type="checkbox"/> Straight teeth |
| <input type="checkbox"/> Angle of helix |   |

**Ball Nose End Mills:**

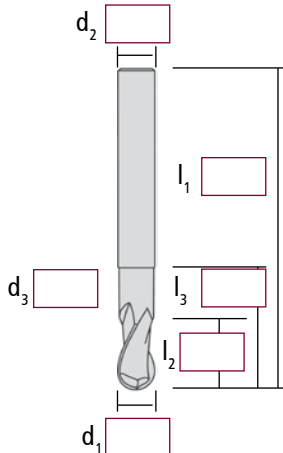

**Corner Radius End Mills:**

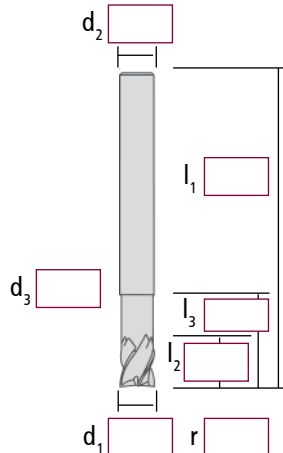

**Toric End Mills:**

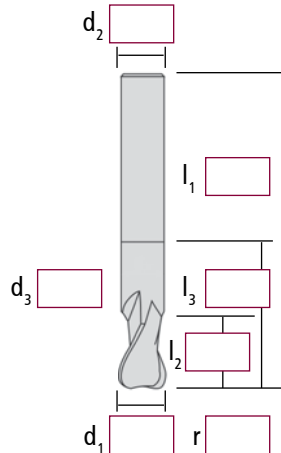

**TRIGAWORX®:**

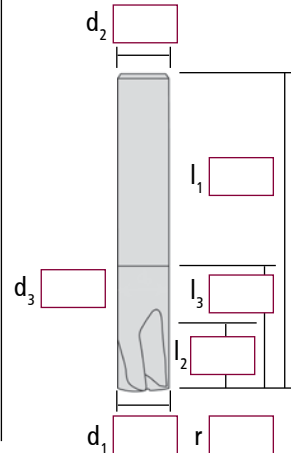

Please fill in your required dimensions.

Indoor service:

Field service:

# PURCHASE/INQUIRY FORM

## Customized Arbors



Please fax to:

**+49 5247 9361-99**

(please copy prior to completion)

Inquiry No./P.O. No.:		Date:	
Company:			
Address:			
Department:		person in charge:	
Phone:	Fax:	Email:	

### Arbor for threaded shank end mill bodies

<input type="text"/>	Requested delivery date	<input type="text"/>	angle	Surface treatment	<input type="text"/>	Nickel	<input type="text"/>	browned		
<input type="text"/>	$d_4$	<input type="text"/>	$d_3$	<input type="text"/>	$d_1$	SK	<input type="text"/>	(size)	<input type="text"/>	(DIN)
<input type="text"/>	HRC	<input type="text"/>	Qty.	<input type="text"/>	balance grade required	HSK	<input type="text"/>	(size)	<input type="text"/>	(form)
<input type="text"/>	$l_1$	<input type="text"/>	$l_3$	<input type="text"/>	Manufactured from material	Internal Coolant Supply	<input type="text"/>	central bore	<input type="text"/>	through the collar

### Arbor for Shell-type Milling Cutter Bodies

<input type="text"/>	Requested delivery date	<input type="text"/>	angle	Surface treatment	<input type="text"/>	Nickel	<input type="text"/>	browned		
<input type="text"/>	$d_4$	<input type="text"/>	$d_3$	<input type="text"/>	$d_1$	SK	<input type="text"/>	(size)	<input type="text"/>	(DIN)
<input type="text"/>	HRC	<input type="text"/>	Qty.	<input type="text"/>	balance grade required	HSK	<input type="text"/>	(size)	<input type="text"/>	(form)
<input type="text"/>	$l_1$	<input type="text"/>	$l_3$	<input type="text"/>	Manufactured from material	Internal Coolant Supply	<input type="text"/>	central bore	<input type="text"/>	through the collar

### Shrinking Arbor

<input type="text"/>	Requested delivery date	<input type="text"/>	angle	Surface treatment	<input type="text"/>	Nickel	<input type="text"/>	brüniert		
<input type="text"/>	$d_4$	<input type="text"/>	$d_3$	<input type="text"/>	$d_1$	SK	<input type="text"/>	(size)	<input type="text"/>	(DIN)
<input type="text"/>	HRC	<input type="text"/>	Qty.	<input type="text"/>	balance grade required	HSK	<input type="text"/>	(size)	<input type="text"/>	(form)
<input type="text"/>	$l_1$	<input type="text"/>	$l_3$	<input type="text"/>	Manufactured from material	Internal Coolant Supply	<input type="text"/>	central bore	<input type="text"/>	through the collar

Note: For cylindrical design please fill in  $d_3$  and  $d_4$ . 4 calendar weeks delivery time with browned surface.

Field service

indoor service

# PURCHASE/INQUIRY FORM

## Customized Adapters



Please fax to:

**+49 5247 9361-99**

(please copy prior to completion)

Inquiry No./P.O. No.:		Date:
Company:		
Address:		
Department:	Person in charge:	
Phone:	Fax:	Email:

### Solid Carbide and Dense Antivibration Adapters for Threaded Shank End Mill Bodies

Requested delivery date
  $d_4$

Qty.
  with clamping flats
 Internal Coolant Supply

### Solid Carbide Adapters for DUOPLUG® System

Requested delivery date
  $d_4$

Qty.
  Internal Coolant Supply

### Morse Taper Adapters for Threaded Shank End Mill Bodies

Requested delivery date
  $d_4$  
Surface treatment

Nickel
  browned

HRC
 MK  Internal Coolant Supply

Material:  Qty.
  Internal Coolant Supply

Note: For cylindrical design please fill in d3 and d4. 4 Calendar weeks delivery time with browned surface.

Indoor service

Field service

# PURCHASE

Your purchase order by fax  
(please copy prior to completion)



Please fax to:

**+49 5247 9361-99**

You can of course also place your order with one of our applications engineers.

Catalogue no.	Description of item	Quantity	Price per item	Total price
<b>Total</b>				

Address:

Different delivery address

Company:

customer number (if known)

Company:

Department:

street

street

name

zip code, city

zip code, city

Our terms of sale are valid for this faxed purchase order.

# QUICKFINDER

**Fit zone diam. of threaded shank end mill bodies:**

Thread size	M 5	M 6	M 8	M 10	M 12	M 16
Length fit zone in mm	5,5	6,5	8,5	10,5	12,5	17,0
Starting torque in Nm	7	10	15	30	50	100

**Thread sizes for Shell-type arbors:**

Pilot diameter in mm	16	22	27	32	40
Fixing screw	M 8	M 10	M 12	M 16	M 20

**Theoretical d4 and l3:**

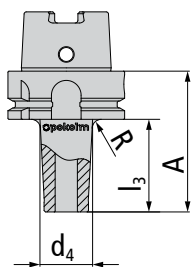

The arbor dimensions d4 and l3 (see illustration at left) are calculated up to the theoretical point of intersection between arbor taper and collar. Please take the radius R (5-8 mm depending on arbor type) into account for practical use.

**Theoretical usable end mill length of Solid carbide end mills in mm\*:**

	diam. of shank (DIN 6535) $d_2 h_2$	2 - 5	6 + 8	10	12 + 14	16 + 18
	length of shank (DIN 6535) $l_2 \begin{smallmatrix} +2 \\ -0 \end{smallmatrix}$	28	36	40	45	48
	diam. of shank (DIN 6535) $d_2 h_2$	20	25	32 + 36		
	length of shank (DIN 6535) $l_2 \begin{smallmatrix} +2 \\ -0 \end{smallmatrix}$	50	56	60		
*this usable length appears through deduction of the DIN-shank-length (l2 according to DIN 6535) from the overall length l1 of the end mill or of the solid carbide adapters. See table above.						

**Features:**

	toric tool		incorporated insert		arbors with zero reach
	7° positive axial rake angle		clamping flat		DUOPLUG®
	12° positive axial rake angle		concave moulding		shim
	17° positive axial rake angle		working depth		internal coolant supply
	Solid Carbide		suitable for high-speed machining		especially suitable f. non-ferr. materials
	chamfer		wet machining possible		on request
	2-point contact milling		dry machining possible		stock item, subject to confirmation
	wet machining required		for direct spindle mounting		available as long as stock lasts
	dry machining required		long series		stainless- acid- and heat resistant
	balance grade		dense antivibration material		



**Pokolm**  
**Frästechnik GmbH & Co. KG**

Adam-Opel-Straße 5  
33428 Harsewinkel  
Germany

Fon: +49 5247 9361-0  
Fax: +49 5247 9361-99

info@pokolm.com  
www.pokolm.com



www.pokolm.com